

# ABSOLUTE DIGIMATIC SCALE UNITS

Catalog No. E4316-572



ABSOLUTE Digimatic Scale Units

# Strengthened lineup includes new coolant-proof models and incorporates absolute scale technology throughout

## ABSOLUTE Digimatic Scale Units

Horizontal single function type



572-202-20

Horizontal multi-function type



572-461

Vertical single function type



572-303-10

Vertical multi-function type



572-561

## Absolute functions

- Absolute scale technology prevents overspeed errors.
- The coordinate origin (ABS point) can be set to desired position and stored. A previously set ABS point is retained even when the power is off, so the current true position is displayed immediately after power-on.

Note: The ABS point reverts to the default value when the battery is removed or replaced.

## Long battery life

- Single function types feature very long battery life (about 20,000 hours), thus providing lower-cost operation and environmental benefit. (Coolant-proof type: about 15,000 hours)

## Small and light

- Smaller display unit allows use as a positioning sensor for jigs and tools as well as on small machine tools.

## ABSOLUTE Coolant-proof Digimatic Scale Units

Horizontal single function type



572-602



572-601



## IP66 protection code compliant (ABSOLUTE Coolant-proof Digimatic Scale Units only)

- Featuring absolute scale technology with a new detection method (electromagnetic induction<sup>\*1\*</sup><sup>\*2</sup>) that makes the unit usable in hostile environments where it is exposed to water or coolant spray.

\*1: For details of the electromagnetic induction detection method, see page 5.

\*2: Patents registered in Japan, the USA and Europe (Germany, the UK, France and Switzerland). Patents pending in India and China.

- Position data can be output to external devices using the waterproof connecting cable dedicated to ABSOLUTE Coolant-proof Digimatic Scale Units.



# Typical applications

**Machine table positioning**

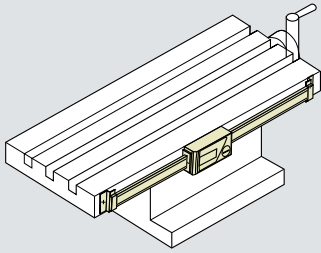

**Drilling machine stroke position**

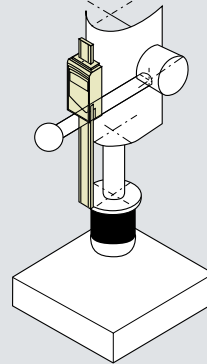

**Tool presetting**

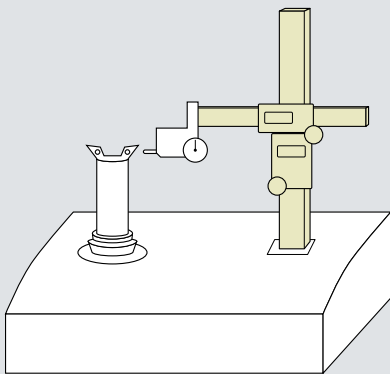

**Focus setting on optical instruments**

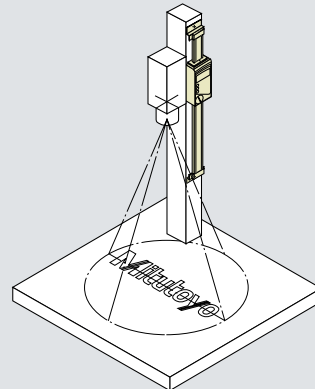

**Special applications**

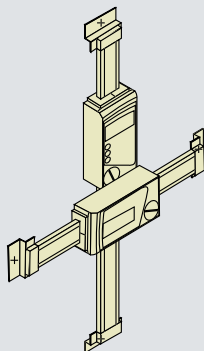

**XY coordinate measurement**

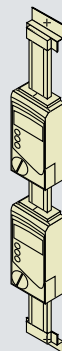

**Multi-head applications**

Non-standard units can be made to special order. Contact your local sales office for more information.

# System diagram

## Scale units

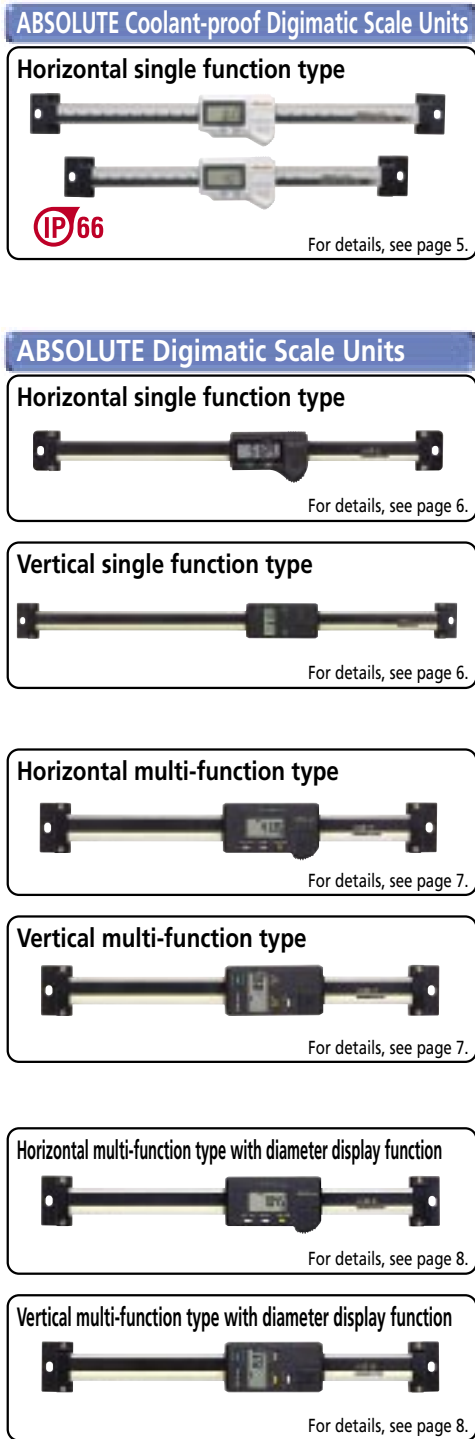



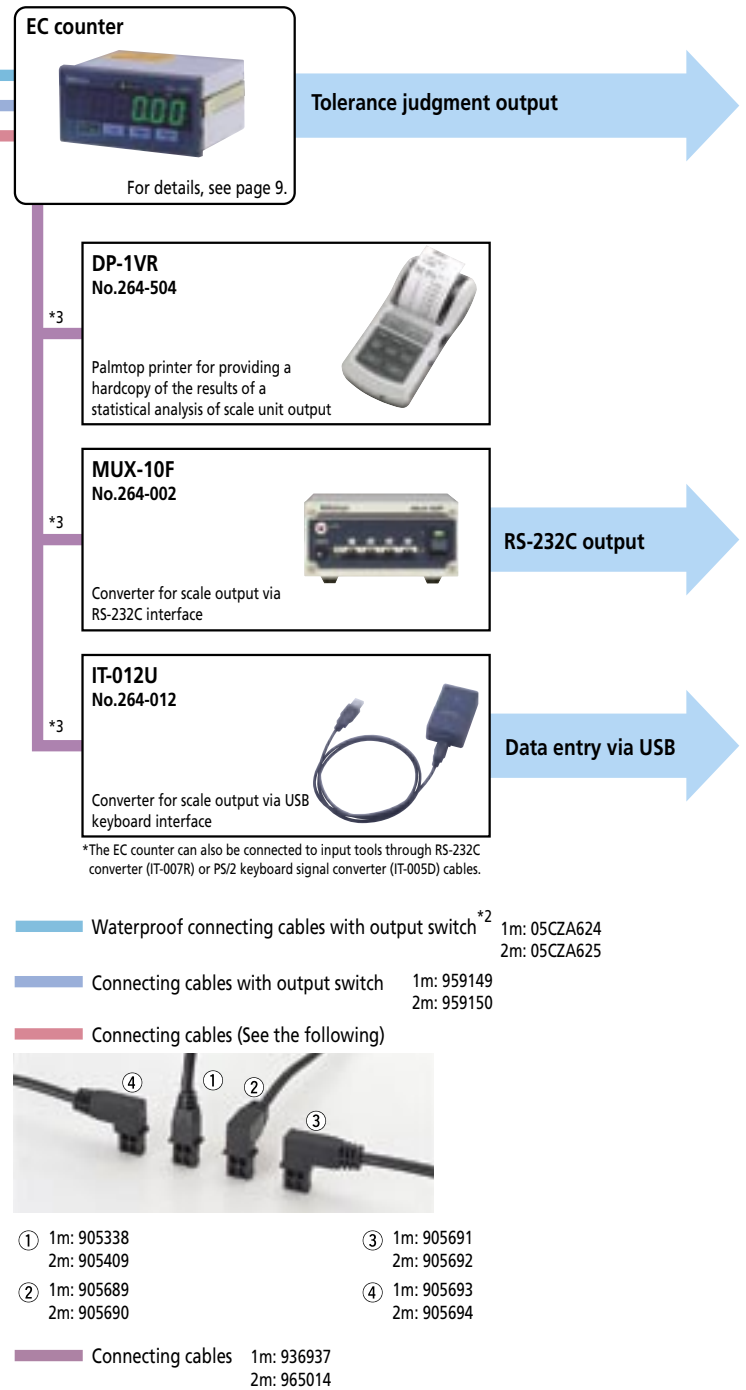



## Display units and peripheral devices



\*1: Tolerance judgment or Digimatic is selected as an output when setting parameters.  
 \*2: Waterproof connecting cable with output switch can be used only for ABSOLUTE Coolant Proof Digimatic Scale Units.  
 \*3: All scale units can also be used by connecting them directly to the DP-1VR, MUX-10F or IT-012U, not through the EC counter. In such cases, use a cable that connects the scale unit with the EC Counter.

# Scale unit functions

| Function                  | Type<br>Function<br>Symbol | ABSOLUTE Coolant-proof<br>Digimatic Scale Units  | ABSOLUTE Digimatic Scale Units   |  |  |
|---------------------------|----------------------------|--|--|--|--|
|                           |                            | <br>Horizontal single function type | <br>Horizontal single function type<br><br>Vertical single function type | <br>Horizontal multi-function type<br><br>Vertical multi-function type | <br>Horizontal multi-function type with<br>diameter display function<br><br>Vertical multi-function type with<br>diameter display function |
| ABS point setting         | <b>ORIGIN</b>              | ✓  | ✓  | ✓  | ✓  |
| Zero-setting              | <b>ZERO</b>                | ✓  | ✓  | ✓  | ✓  |
| Direction changeover      | <b>DIR</b>                 | -  | -  | ✓  | -  |
| Presetting                | <b>PRE</b>                 | -  | -  | ✓  | ✓  |
| Display holding           | <b>HOLD</b>                | -  | ✓✓   | ✓  | ✓  |
| Data output               | <b>M-SPC</b>               | ✓  | ✓  | ✓  | ✓  |
| Diameter display          | <b>Dia.</b>                | -  | -  | -  | ✓  |
| Alarm for faulty counting | <b>E</b>                   | ✓  | ✓  | ✓  | ✓  |
| Low battery-voltage alarm | <b>B</b>                   | ✓  | ✓  | ✓  | ✓  |

✓ Standard feature ✓✓ A hold switch (option: No. 959143) must be used.

\*In all scale units, switching between ABSOLUTE Mode and Incremental Mode is possible.

The ZERO/ABS key allows the display to be zero-set at any slider position along the beam for incremental comparison measurements.

This key also allows return to ABSOLUTE Mode with a display of the true position from the origin point.

Highly robust design. The Digimatic scale is safely embedded in a hardened, stainless steel bar.

The following is a brief description of each function.

## ORIGIN

ABS point (0.00) can be set to the desired point and stored.  
Can be used only when the unit is in ABSOLUTE Mode

## ZERO

Displayed value can be cleared (zero-set) at the desired position.  
Can be used only when the unit is in Incremental Mode.

## DIR

Reverses the direction of measurement.

## PRE

Desired value can be preset as a displayed value. A ± sign can also be set.

## HOLD

Holds the displayed value. When this function is released, the display reverts to displaying the current true position.

## M-SPC

The main unit features an output connector, which allows connection with the DP-1VR digimatic mini processor or other devices. When the DP-1VR is connected, various statistical analysis processing, creation of histograms, and printing can be performed.

## Dia.

The doubled scale displacement can be displayed. This convenient feature can be used to display the diameter of workpieces being machined on a lathe.

## E

If a position reading cannot be displayed due to noise or other reasons, an error is displayed.

## B

B is displayed when battery voltage becomes low, indicating that the battery needs to be replaced soon.

# ABSOLUTE Coolant-proof Digimatic Scale Units



Horizontal single function type



IP66

Inch type, Inch/Metric switching type, or Metric type can be selected.

FUNCTION **ORIGIN** **ZERO** **M-SPC**<sup>\*1</sup> **E** **B**

## SPECIFICATIONS

|               |                        |              |              |              |
|---------------|------------------------|--------------|--------------|--------------|
| Inch          | Order No.              | 572-610      | 572-611      | 572-612      |
|               | Range                  | 0-4"         | 0-6"         | 0-8"         |
|               | Accuracy <sup>*2</sup> | .001"        | .001"        | .001"        |
| Inch / Metric | Order No.              | 572-613      | 572-614      | 572-615      |
|               | Range                  | 0-4"         | 0-6"         | 0-8"         |
|               | Accuracy <sup>*2</sup> | 0.03mm/.001" | 0.03mm/.001" | 0.03mm/.001" |
| Metric        | Order No.              | 572-600      | 572-601      | 572-602      |
|               | Range                  | 0-100mm      | 0-150mm      | 0-200mm      |
|               | Accuracy <sup>*2</sup> | 0.03mm       | 0.03mm       | 0.03mm       |
| Dimensions    | L1 / L2                | 209mm/185mm  | 259mm/235mm  | 311mm/287mm  |
|               | Mass                   | 390g         | 410g         | 430g         |

\*1 Only connecting cables with an output switch dedicated for ABSOLUTE Coolant-proof Digimatic Scale Units (No.05CZA624/1m, No.05CZA625/2m) can be used.



\*2 Not including quantizing error  $\pm 1$  count

\*3 High slider speed does not cause data errors. Position feedback and output data may not be used while the slider is moving.

\*4 Patents registered in Japan, the USA, and Europe (Germany, the UK, France, and Switzerland), patents pending in India and China.

\*5 Protection code: IP66. This product is not waterproof. (Anti-corrosion treatment is required after use.)

\*6 Tapped insert: No.5-40 UNC (Inch type, Inch/Metric switching type) / 2-M3x0.5 (Metric type) Screwed depth on the rear side of display unit: under 2mm

| Protection                                       | Level              | Description   |
|--|--------------------|---|
| Protection against the ingress of foreign bodies | 6: Dustproof       | Complete protection against ingress of dust   |
| Protection against the ingress of water          | 6: Water resistant | A powerful water jet directed at the enclosure from any direction has no harmful effect |

## COMMON SPECIFICATIONS

Resolution: 0.01mm or 0.0005"/0.01mm

Repeatability: 0.01mm

Response speed<sup>\*3</sup>: Unlimited

Length standard: ABSOLUTE electromagnetic induction encoder<sup>\*4</sup>

Dust/Water protection level<sup>\*5</sup>: IP66

Battery: SR44 (1pc., 938882)

Battery life: Approx. 1.5 years under normal use

## DIMENSIONS Unit:mm

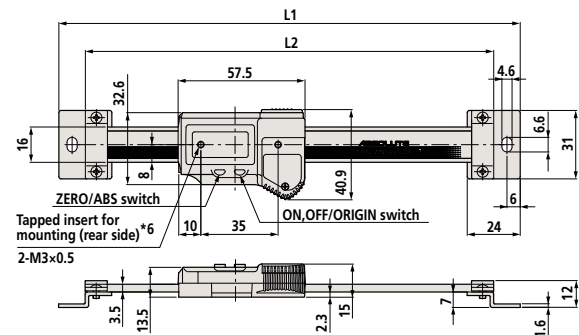

## What is electromagnetic induction?

- Current I1, which changes with time, flows through coil L1, generating a magnetic field around coil L1 and adjacent coil L2.
- A voltage V2 is induced in L2 which causes a current I2 to flow in the direction that opposes change in the magnetic field.

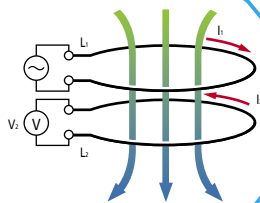

This principle is applied to ABSOLUTE Coolant Proof Digimatic Scales. The induction between coils offers excellent water resistance and oil resistance. Absolute detection is achieved by synthesizing position data with arrangements of two-row graduations on the main scale.

Mitutoyo

# ABSOLUTE Digimatic Scale Units



## Horizontal single function type



Either Inch/Metric switching type or Metric type can be selected.

FUNCTION **ORIGIN** **ZERO** **HOLD**<sup>\*1</sup> **M-SPC**<sup>\*2</sup> **E** **B**

### SPECIFICATIONS

| Inch / Metric          | Order No. | 572-210-20   | 572-211-20   | 572-212-20   | 572-213-10   |
|------------------------|-----------|--------------|--------------|--------------|--------------|
| Range                  |           | 0-4"         | 0-6"         | 0-8"         | 0-12"        |
| Accuracy <sup>*3</sup> |           | 0.03mm/.001" | 0.03mm/.001" | 0.03mm/.001" | 0.04mm/.002" |
| Metric                 | Order No. | 572-200-20   | 572-201-20   | 572-202-20   | 572-203-10   |
| Range                  |           | 0-100mm      | 0-150mm      | 0-200mm      | 0-300mm      |
| Accuracy <sup>*3</sup> |           | 0.03mm       | 0.03mm       | 0.03mm       | 0.04mm       |
| Dimensions             | L1 / L2   | 209mm/185mm  | 259mm/235mm  | 311mm/287mm  | 444mm/420mm  |
| Mass                   |           | 235g         | 255g         | 275g         | 370g         |

### COMMON SPECIFICATIONS

Resolution: 0.01mm or 0.0005"/0.01mm  
 Repeatability: 0.01mm or 0.0005"/0.01mm  
 Response speed: Unlimited<sup>\*4</sup>  
 Length standard: ABSOLUTE electrostatic capacitance type linear encoder  
 Battery: SR44 (1pc. 938882)  
 Battery life: Approx. 3.5 years under normal use

### DIMENSIONS Unit:mm

572-200-20~572-202-20  
 572-210-20~572-212-20

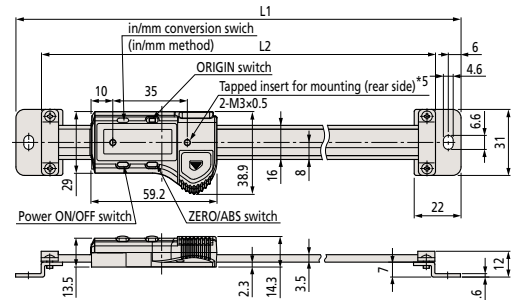

572-203-10, 572-213-10

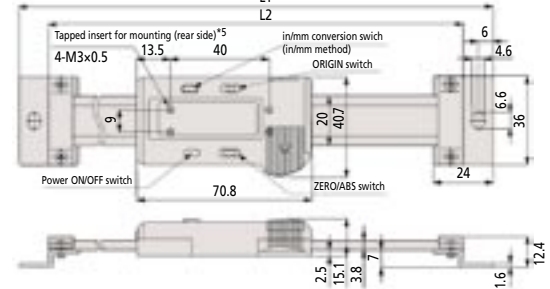

## Vertical single function type



Either Inch/Metric switching type or Metric type can be selected.

FUNCTION **ORIGIN** **ZERO** **HOLD**<sup>\*1</sup> **M-SPC**<sup>\*2</sup> **E** **B**

### SPECIFICATIONS

| Inch / Metric          | Order No. | 572-310-10   | 572-311-10   | 572-312-10   | 572-313-10   |
|------------------------|-----------|--------------|--------------|--------------|--------------|
| Range                  |           | 0-4"         | 0-6"         | 0-8"         | 0-12"        |
| Accuracy <sup>*3</sup> |           | 0.03mm/.001" | 0.03mm/.001" | 0.03mm/.001" | 0.04mm/.002" |
| Metric                 | Order No. | 572-300-10   | 572-301-10   | 572-302-10   | 572-303-10   |
| Range                  |           | 0-100mm      | 0-150mm      | 0-200mm      | 0-300mm      |
| Accuracy <sup>*3</sup> |           | 0.03mm       | 0.03mm       | 0.03mm       | 0.04mm       |
| Dimensions             | L1 / L2   | 244mm/220mm  | 294mm/270mm  | 344mm/320mm  | 444mm/420mm  |
| Mass                   |           | 235g         | 255g         | 275g         | 370g         |

### COMMON SPECIFICATIONS

Resolution: 0.01mm or 0.0005"/0.01mm  
 Repeatability: 0.01mm or 0.0005"/0.01mm  
 Response speed: Unlimited<sup>\*4</sup>  
 Length standard: ABSOLUTE electrostatic capacitance type linear encoder  
 Battery: SR44 (1pc. 938882)  
 Battery life: Approx. 3.5 years under normal use

### DIMENSIONS Unit:mm

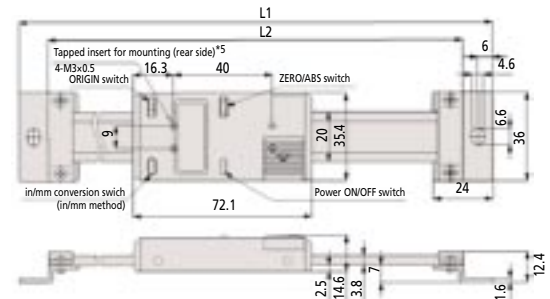

### OPTIONAL ACCESSORIES

Hold switch



959143

Connecting cable with output switch



1m:959149  
 2m:959150

\*1 A hold switch (No. 959143), an optional accessory, is required. The output function cannot be used at the same time.  
 \*2 Connecting cables on page 3 and connecting cables with output switch (No. 959149/1m and No. 959150/2m) can be used.  
 \*3 Not including quantizing error ±1 count  
 \*4 High slider speed does not cause data errors. Position feedback and output data may not be used while the slider is moving.  
 \*5 Tapped insert: No.5-40 UNC (Inch/Metric switching type) / 4-M3x0.5 (Metric type) Screwed depth on the rear side of display unit: under 2mm



## Horizontal multi-function type



Either Inch/Metric switching type or Metric type can be selected.

FUNCTION ORIGIN ZERO PRE DIR HOLD M-SPC E B

### SPECIFICATIONS

| Inch / Metric | Order No. | 572-470      | 572-471      | 572-472      | 572-473      | 572-474      | 572-475      | 572-476           | 572-477            |
|---------------|-----------|--------------|--------------|--------------|--------------|--------------|--------------|-------------------|--------------------|
|               | Range     |              | 0-4"         | 0-6"         | 0-8"         | 0-12"        | 0-18"        | 0-24"             | 0-32"              |
| Accuracy *1   |           | 0.03mm/.001" | 0.03mm/.001" | 0.03mm/.001" | 0.04mm/.002" | 0.04mm/.002" | 0.05mm/.002" | 0.06mm/.0025"     | 0.07mm/.0025"      |
| Metric        | Order No. | 572-460      | 572-461      | 572-462      | 572-463      | 572-464      | 572-465      | 572-466           | 572-467            |
|               | Range     |              | 0-100mm      | 0-150mm      | 0-200mm      | 0-300mm      | 0-450mm      | 0-600mm           | 0-800mm            |
| Accuracy *1   |           | 0.03mm       | 0.03mm       | 0.03mm       | 0.04mm       | 0.04mm       | 0.05mm       | 0.06mm            | 0.07mm             |
| Dimensions    | L1 / L2   | 244mm/220mm  | 294mm/270mm  | 344mm/320mm  | 444mm/420mm  | 594mm/570mm  | 774mm/750mm  | 974mm/950mm       | 1174mm/1150mm      |
|               | t / G / H |              |              |              |              |              |              | 6mm/23.2mm/14.6mm | 10mm/27.2mm/18.6mm |
| Mass          |           | 250g         | 280g         | 310g         | 370g         | 760g         | 900g         | 1710g             | 2040g              |

### COMMON SPECIFICATIONS

Resolution: 0.01mm or 0.0005"/0.01mm

Repeatability: 0.01mm or 0.0005"/0.01mm

Response speed\*2: Unlimited

Length standard: ABSOLUTE electrostatic capacitance type linear encoder

Battery: SR44 (1pc. 938882)

Battery life: Approx. 5000 hours in continuous use

### DIMENSIONS Unit:mm

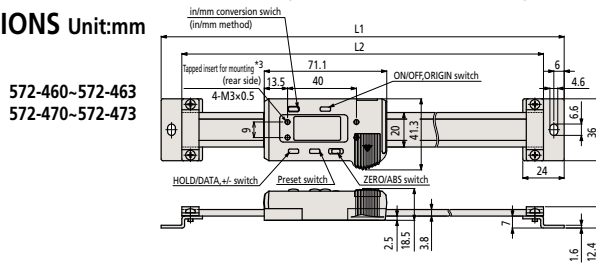

572-460~572-463  
572-470~572-473

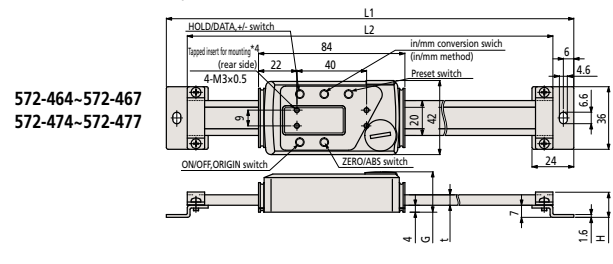

572-464~572-467  
572-474~572-477

## Vertical multi-function type



Either Inch/Metric switching type or Metric type can be selected.

FUNCTION ORIGIN ZERO PRE DIR HOLD M-SPC E B

### SPECIFICATIONS

| Inch / Metric | Order No. | 572-570      | 572-571      | 572-572      | 572-573      | 572-574      | 572-575      | 572-576           | 572-577            |
|---------------|-----------|--------------|--------------|--------------|--------------|--------------|--------------|-------------------|--------------------|
|               | Range     |              | 0-4"         | 0-6"         | 0-8"         | 0-12"        | 0-18"        | 0-24"             | 0-32"              |
| Accuracy *1   |           | 0.03mm/.001" | 0.03mm/.001" | 0.03mm/.001" | 0.04mm/.002" | 0.04mm/.002" | 0.05mm/.002" | 0.06mm/.0025"     | 0.07mm/.0025"      |
| Metric        | Order No. | 572-560      | 572-561      | 572-562      | 572-563      | 572-564      | 572-565      | 572-566           | 572-567            |
|               | Range     |              | 0-100mm      | 0-150mm      | 0-200mm      | 0-300mm      | 0-450mm      | 0-600mm           | 0-800mm            |
| Accuracy *1   |           | 0.03mm       | 0.03mm       | 0.03mm       | 0.04mm       | 0.04mm       | 0.05mm       | 0.06mm            | 0.07mm             |
| Dimensions    | L1 / L2   | 244mm/220mm  | 294mm/270mm  | 344mm/320mm  | 444mm/420mm  | 594mm/570mm  | 774mm/750mm  | 974mm/950mm       | 1174mm/1150mm      |
|               | t / G / H |              |              |              |              |              |              | 6mm/23.2mm/14.6mm | 10mm/27.2mm/18.6mm |
| Mass          |           | 250g         | 280g         | 310g         | 370g         | 760g         | 900g         | 1710g             | 2040g              |

### COMMON SPECIFICATIONS

Resolution: 0.01mm or 0.0005"/0.01mm

Repeatability: 0.01mm or 0.0005"/0.01mm

Response speed\*2: Unlimited

Length standard: ABSOLUTE electrostatic capacitance type linear encoder

Battery: SR44 (1pc. 938882)

Battery life: Approx. 5000 hours in continuous use

### DIMENSIONS Unit:mm

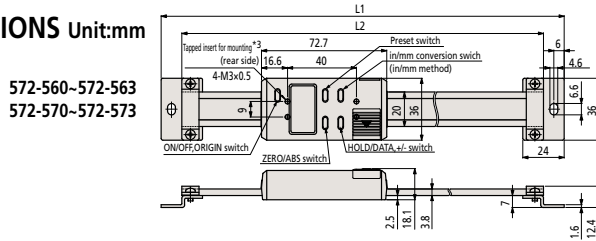

572-560~572-563  
572-570~572-573

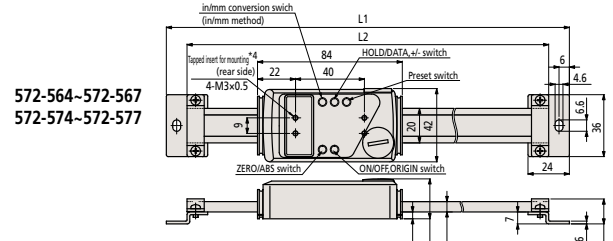

572-564~572-567  
572-574~572-577

\*1 Not including quantizing error ±1 count

\*2 High slider speed does not cause data errors. Position feedback and output data may not be used while the slider is moving.

\*3 Tapped insert: No.5-40 UNC (Inch/Metric switching type) / 4-M3x0.5 (Metric type) Screwed depth on the rear side of display unit: under 2mm

\*4 Tapped insert: No.5-40 UNC (Inch/Metric switching type) / 4-M3x0.5 (Metric type) Screwed depth on the rear side of display unit: under 3mm





Horizontal multi-function type with diameter display function

Made-to-order products



Either Inch/Metric switching type or Metric type can be selected.

FUNCTION ORIGIN ZERO PRE HOLD M-SPC Dia. E B

SPECIFICATIONS

|               |             |             |             |             |             |                   |                    |             |               |
|---------------|-------------|-------------|-------------|-------------|-------------|-------------------|--------------------|-------------|---------------|
| Inch / Metric | Order No.   | 572-490-10  | 572-491-10  | 572-492-10  | 572-493-10  | 572-494-10        | 572-495-10         | 572-496-10  | 572-497-10    |
|               | Range       | 0-4"        | 0-6"        | 0-8"        | 0-12"       | 0-18"             | 0-24"              | 0-32"       | 0-40"         |
| Metric        | Order No.   | 572-480-10  | 572-481-10  | 572-482-10  | 572-483-10  | 572-484-10        | 572-485-10         | 572-486-10  | 572-487-10    |
|               | Range       | 0-100mm     | 0-150mm     | 0-200mm     | 0-300mm     | 0-450mm           | 0-600mm            | 0-800mm     | 0-1000mm      |
|               | Accuracy *1 | 0.03mm      | 0.03mm      | 0.03mm      | 0.04mm      | 0.04mm            | 0.05mm             | 0.06mm      | 0.07mm        |
| Dimensions    | L1 / L2     | 244mm/220mm | 294mm/270mm | 344mm/320mm | 444mm/420mm | 594mm/570mm       | 774mm/750mm        | 974mm/950mm | 1174mm/1150mm |
|               | t / G / H   |             |             |             |             | 6mm/23.2mm/14.6mm | 10mm/27.2mm/18.6mm |             |               |
|               | Mass        | 250g        | 280g        | 310g        | 370g        | 760g              | 900g               | 1710g       | 2040g         |

COMMON SPECIFICATIONS

Resolution: 0.01mm or 0.0005"/0.01mm

Repeatability: 0.01mm or 0.0005"/0.01mm (Radius indication, not diameter)

Response speed\*2: Unlimited

Length standard: ABSOLUTE electrostatic capacitance type linear encoder

Battery: SR44 (1pc. 938882)

Battery life: Approx. 5000 hours in continuous use

DIMENSIONS Unit:mm

572-480-10~572-483-10  
572-490-10~572-493-10

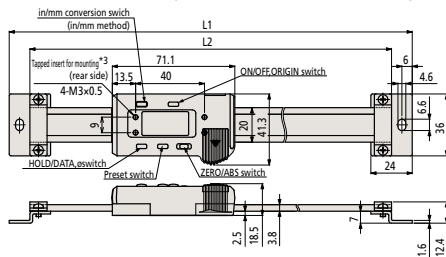

572-483-10~572-487-10  
572-494-10~572-497-10

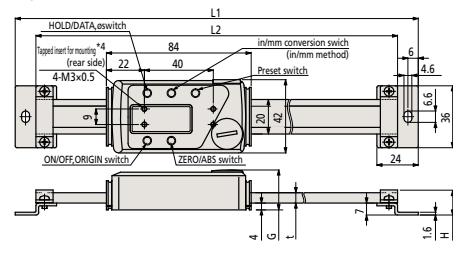

Vertical multi-function type with diameter display function

Made-to-order products



Either Inch/Metric switching type or Metric type can be selected.

FUNCTION ORIGIN ZERO PRE HOLD M-SPC Dia. E B

SPECIFICATIONS

|               |             |             |             |             |             |                   |                    |             |               |
|---------------|-------------|-------------|-------------|-------------|-------------|-------------------|--------------------|-------------|---------------|
| Inch / Metric | Order No.   | 572-590-10  | 572-591-10  | 572-592-10  | 572-593-10  | 572-594-10        | 572-595-10         | 572-596-10  | 572-597-10    |
|               | Range       | 0-4"        | 0-6"        | 0-8"        | 0-12"       | 0-18"             | 0-24"              | 0-32"       | 0-40"         |
| Metric        | Order No.   | 572-580-10  | 572-581-10  | 572-582-10  | 572-583-10  | 572-584-10        | 572-585-10         | 572-586-10  | 572-587-10    |
|               | Range       | 0-100mm     | 0-150mm     | 0-200mm     | 0-300mm     | 0-450mm           | 0-600mm            | 0-800mm     | 0-1000mm      |
|               | Accuracy *1 | 0.03mm      | 0.03mm      | 0.03mm      | 0.04mm      | 0.04mm            | 0.05mm             | 0.06mm      | 0.07mm        |
| Dimensions    | L1 / L2     | 244mm/220mm | 294mm/270mm | 344mm/320mm | 444mm/420mm | 594mm/570mm       | 774mm/750mm        | 974mm/950mm | 1174mm/1150mm |
|               | t / G / H   |             |             |             |             | 6mm/23.2mm/14.6mm | 10mm/27.2mm/18.6mm |             |               |
|               | Mass        | 250g        | 280g        | 310g        | 370g        | 760g              | 900g               | 1710g       | 2040g         |

COMMON SPECIFICATIONS

Resolution: 0.01mm or 0.0005"/0.01mm

Repeatability: 0.01mm or 0.0005"/0.01mm (Radius indication, not diameter)

Response speed\*2: Unlimited

Length standard: ABSOLUTE electrostatic capacitance type linear encoder

Battery: SR44 (1pc. 938882)

Battery life: Approx. 5000 hours in continuous use

DIMENSIONS Unit:mm

572-480-10~572-583-10  
572-490-10~572-593-10

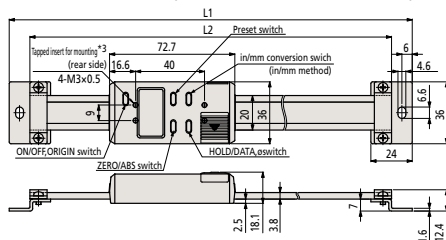

572-584-10~572-587-10  
572-594-10~572-597-10

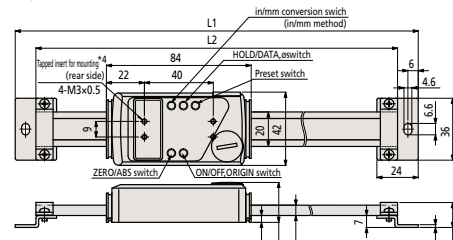

\*1 Not including quantizing error ±1 count

\*2 High slider speed does not cause data errors. Position feedback and output data may not be used while the slider is moving.

\*3 Tapped insert: No.5-40 UNC (Inch/Metric switching type) / 4-M3x0.5 (Metric type) Screwed depth on the rear side of display unit: under 2mm

\*4 Tapped insert: No.5-40 UNC (Inch/Metric switching type) / 4-M3x0.5 (Metric type) Screwed depth on the rear side of display unit: under 3mm

# Display Unit

## EC counter

### FEATURES

This Digimatic Display Unit with GO/NG judgement function offers a large, easily read display for a Digimatic Scale Unit. The bright LED readout is ideal for low-light situations or when the scale unit must be located where its own display cannot be viewed directly.

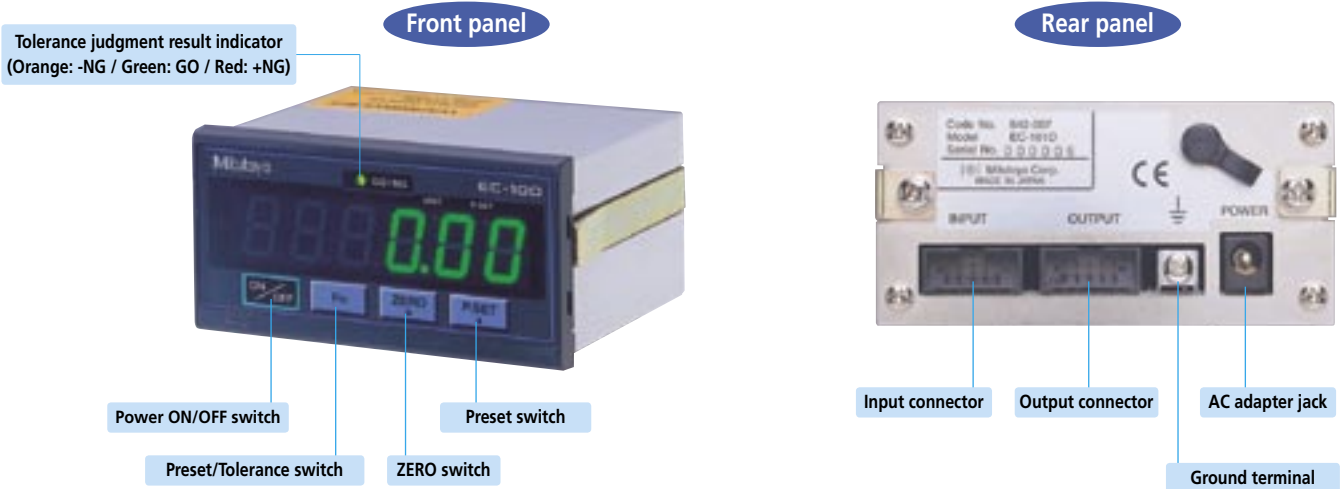

### SPECIFICATIONS

|                                     |   |  |
|-------------------------------------|---|--|
| Order No.                           | 542-007 <sup>*1</sup>                                 |  |
| Resolution                          | 0.01mm(±9999.99mm)                                    |  |
|                                     | .0005"(±99.9995") / .001"(±999.99")                   |  |
| Display                             | 0.001mm(±999.999mm)                                   |  |
|                                     | .00005"(±9.99995") / .0001"(±99.999")                 |  |
| Display                             | Display of + and - signs and 6-digit measurement data |  |
| Tolerance judgment result indicator | LED (Orange, Green, Red)                              |  |
| Output (switching control)          | tolerance judgment results output                     | -NG / GO / +NG (open-collector output) |
|                                     | data output   | Digimatic                              |
| Input                               | Preset, HOLD  |  |
| Power Supply                        | AC adapter <sup>*1</sup>                              |  |
| Operating temperature               | 0°C to 40°C   |  |
| Storage temperature                 | -10°C to 50°C   |  |
| Mass                                | 220g  |  |

<sup>\*1</sup> Standard accessory

The dedicated AC adapter AD908 is supplied with one of the following, according to the order number.

- 542-007:AD908N(No.526688)(for Japan)
- 542-007A:AD908AN(No.526688A)(for USA)
- 542-007D:AD908AD(No.526688D)(for EU)
- 542-007E:AD908EN(No.526688E)(for UK)
- 542-007DC:AD908DC(No.526688DC)(for China)
- 542-007K:AD908K(No.526688K)(for Korea)

Optional accessories

- Connecting cables: 936937(1m),965014(2m)
- DC plug PJ-2: 214938
- Connecting cable: C162-155(2m)

### DIMENSIONS Unit:mm

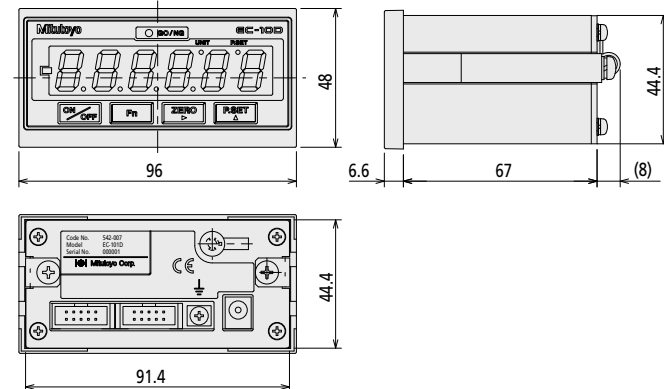

## Output connector specifications

The output can be switched to either the tolerance judgment I/O or Digimatic output.

The following shows the detailed specifications when the tolerance judgment I/O is selected.

(1) Connecting cable: C162-155(2m)

(2) Output connector pin assignment

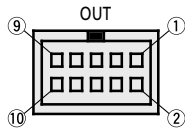

| Pin No.                           | I/O | Signal name | Function  | Color of the lead wire in the optional I/O cable |
|-----------------------------------|-----|-------------|---|--|
| 1                                 |     | COM         | Connection to internal GND  | Brown,Black                                      |
| 2                                 | O   | +NG         | Tolerance output: Relevant pin output is low level. When an error is displayed: +NG and -NG pins are low level. | Brown,Red  |
| 3                                 | O   | GO          |   | Yellow,Black                                     |
| 4                                 | O   | -NG         |   | Yellow,Red                                       |
| 5                                 | I   | HOLD        | HOLD input  | Green,Black                                      |
| 6                                 | I   | P.SET       | Preset input  | Green,Red  |
| 10                                |     | F.G.        | Shield (internally connected to the case)   | White,Red  |
| Leave the other pins unconnected. |     |             |   |  |

Note that the output functions of the connector pins are different for the Digimatic output mode. The I/O cable should be connected after the output mode is set.

The free end of the I/O cable terminates in seven wires which have to be connected according to purpose. Connect the F.G. line (with solderless terminals) to the ground terminal of the equipment to be connected.

## Timing chart

### Tolerance output

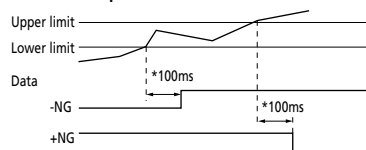

### Preset and HOLD inputs

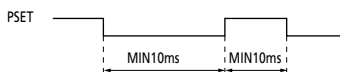

\*Preset and HOLD input signals are active low.

### (3) I/O circuit

a. Output circuit (-NG / GO / +NG)

The transistor is on during open-collector output at low level.

Maximum applied voltage = 24VDC  
Maximum sink current = 10mA  
Maximum saturation voltage = 0.7VDC

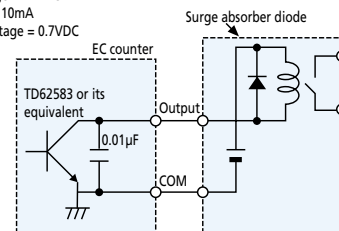

b. Input circuit (Preset, HOLD)

Input is valid at "low" level.

Maximum source current = 1mA  
Input voltage: High level = 4-24VDC  
Low level = 1VDC maximum

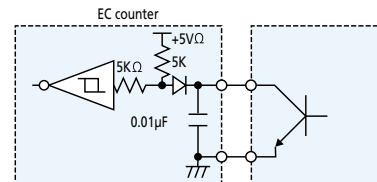

Reference circuit for external devices.  
Use open-collector output, relay output, or the like.

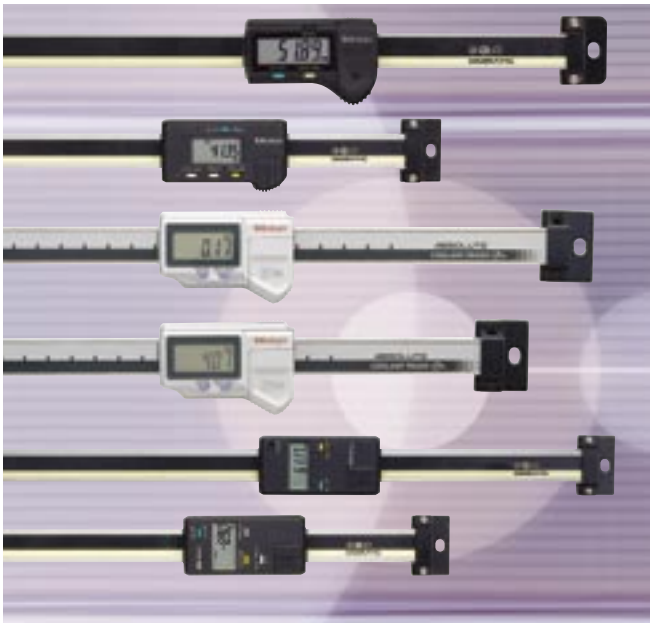

Our products are classified as regulated items under Japanese Foreign Exchange and Foreign Trade Law. Please consult us in advance if you wish to export our products to any other country. If the purchased product is exported, even though it is not a regulated item (Catch-All controls item), the customer service available for that product may be affected. If you have any questions, please consult your local Mitutoyo sales office.

- Test Equipment and Seismometers
- Digital Scale and DRO Systems
- Small Tool Instruments and Data Management

Note: All information regarding our products, and in particular the illustrations, drawings, dimensional and performance data contained in this pamphlet, as well as other technical data are to be regarded as approximate average values. We therefore reserve the right to make changes to the corresponding designs, dimensions and weights. The stated standards, similar technical regulations, descriptions and illustrations of the products were valid at the time of printing. Only quotations submitted by ourselves may be regarded as definitive.

Our products are classified as regulated items under Japanese Foreign Exchange and Foreign Trade Law. Please consult us in advance if you wish to export our products to any other country. If the purchased product is exported, even though it is not a regulated item (Catch-All controls item), the customer service available for that product may be affected. If you have any questions, please consult your local Mitutoyo sales office.

**Mitutoyo Corporation**  
 20-1, Sakado 1-Chome,  
 Takatsu-ku, Kawasaki-shi,  
 Kanagawa 213-8533, Japan  
 T +81 (0) 44 813-8230  
 F +81 (0) 44 813-8231  
<http://www.mitutoyo.co.jp>

