

Hardness Testing Machines Overview HM/HV/HR/HH Series

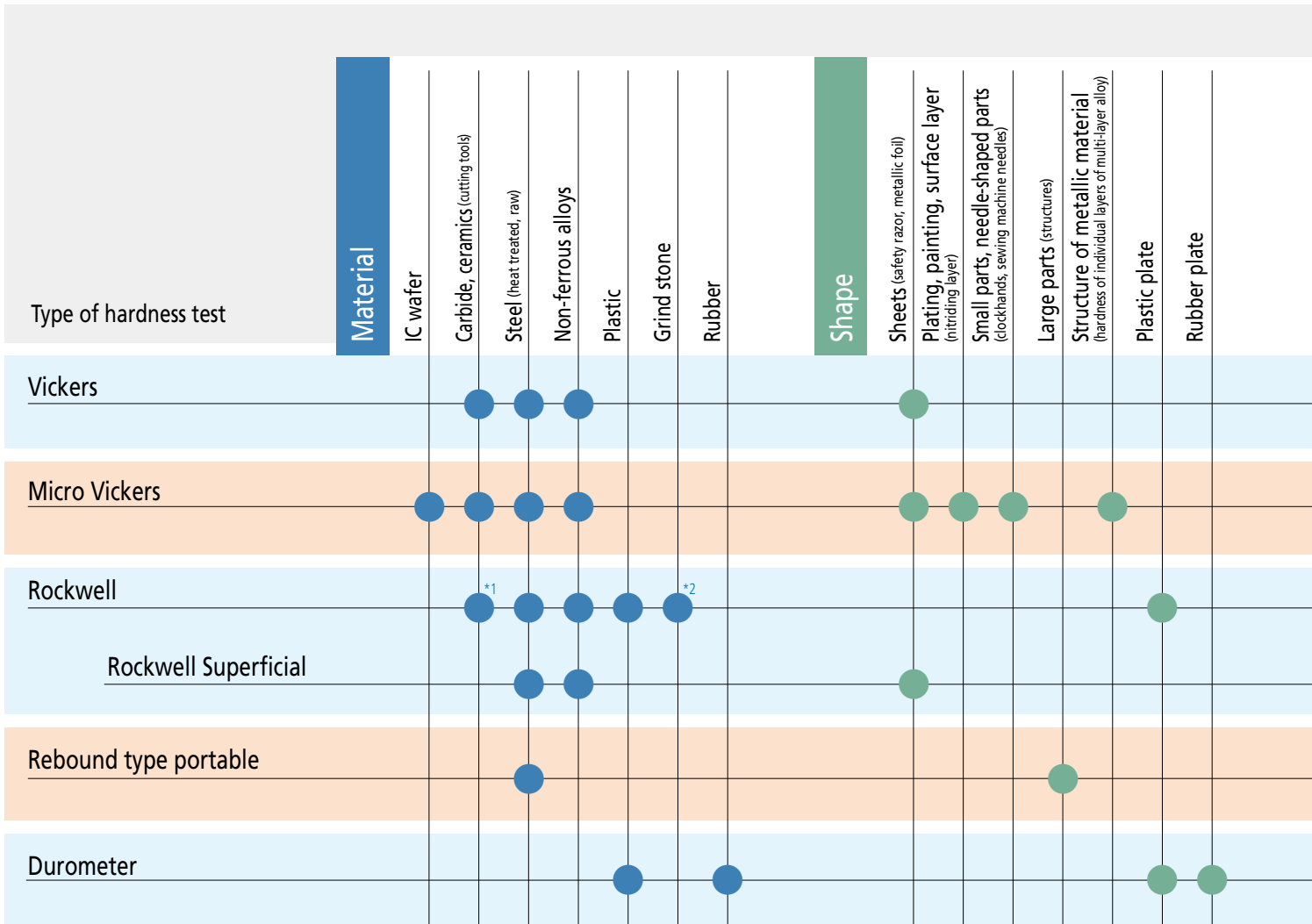

Types of hardness test and recommended selection criteria for hardness testing machines



●: Suitable ▲: Fairly suitable *1: A scale *2: H scale *3: Test force 2.942 N 9.807 N *4: Test force 0.9807 N 9.807 N *5: Test force 2.942 N or more



Inspection, judgment

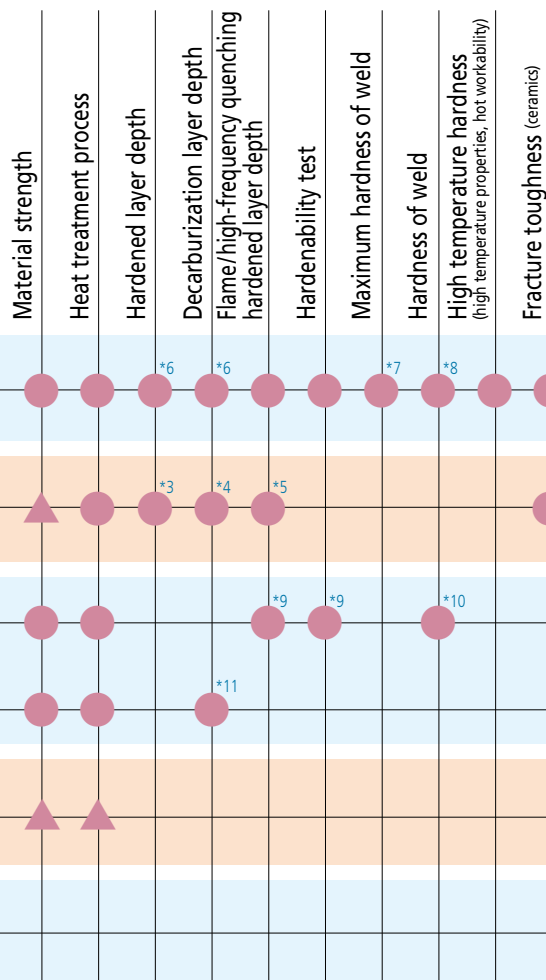

Vickers hardness testing machine HV-100 Series	6
Micro Vickers hardness testing machines HM-200 Series, HM-100 Series	8
Rockwell hardness testing machine HR Series	20
Hardmatic HH-411 (Rebound type portable hardness tester)	44
Hardmatic HH-300 Series (Durometers for sponge, rubber, and plastic)	46

*6: Test force 9.807 N *7: Test force 98.07 N *8: Test force 294.2 N *9: C scale *10: B, C scale *11: 15 N, 30 N scale

A wide range of products for every purpose, from Mitutoyo's Hardness Testing Machines

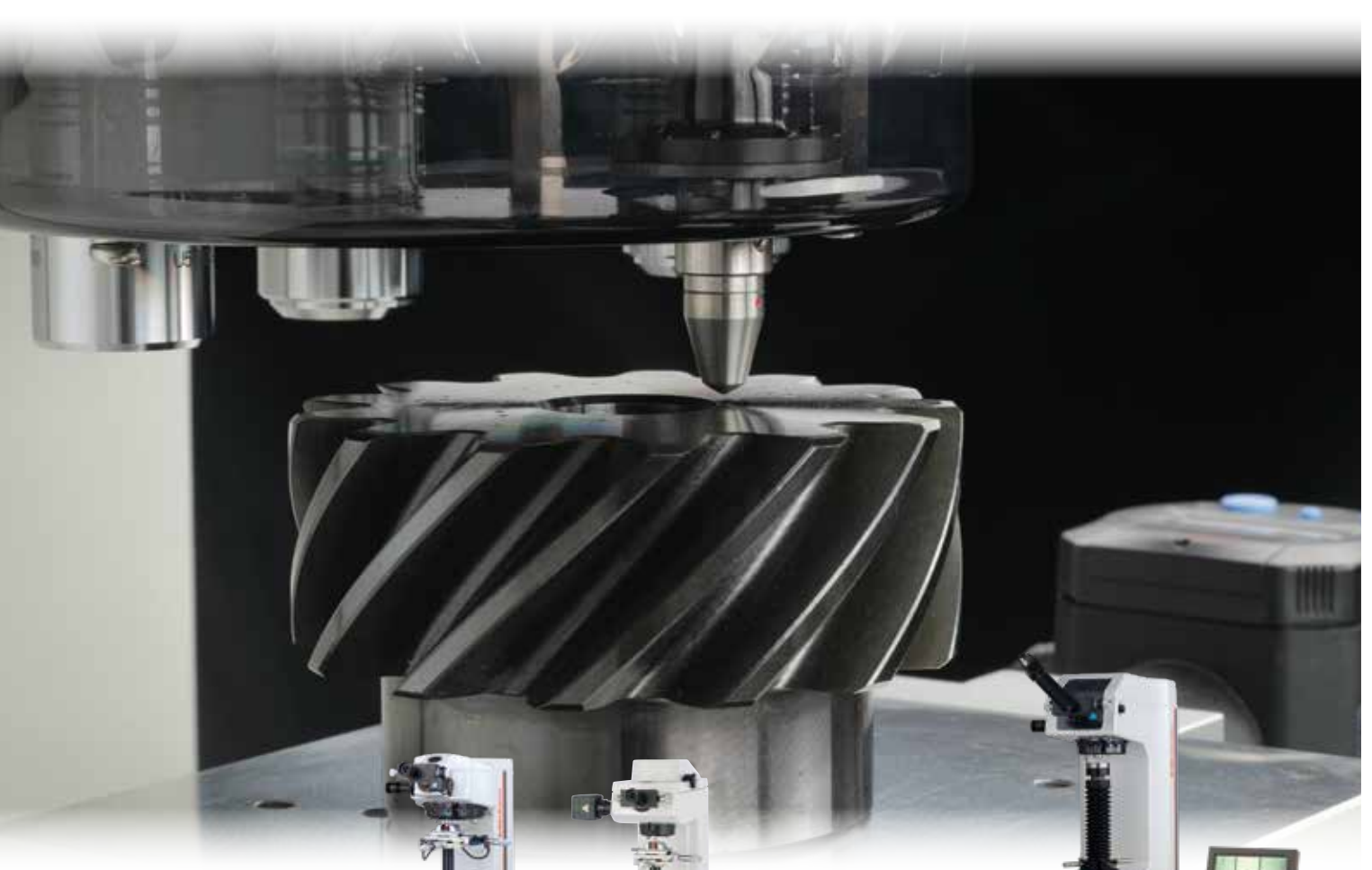

HM

HM-200 Series: [Page 8](#) HM-100 Series: [Page 11](#)

Micro Vickers hardness testing machines

Support for a wide range of system compositions, with test force from 0.4903 to 19610 mN

HV

HV-100 Series: [Page 12](#)

Vickers hardness testing machine

Advanced model supporting test force from 2.942 to 490.3 N

Among the many types of material testing equipment, hardness testing machines provide the simplest testing methods and they play a vital role in research through to production and commercial transactions. Mitutoyo meets diverse needs by offering a broad lineup of efficient machines for testing the hardness of many kinds materials ranging from hard metals to soft plastics and rubber.

CE compliance

The products in this brochure are safe designs conforming to low voltage, EMC and machinery directives of the EU.
(Excludes some products.)



a smart model to a high-end CNC machine.



HR

HR-600 Series: [Page 22](#)

HR-530 Series: [Page 26](#)

HR-200/300/400 Series: [Page 30](#)



Rockwell hardness testing machines

Extensive line-up ranging from a smart model to a CNC machine

HH



HH-411: [Page 44](#)

HH-300: [Page 46](#)



Portable hardness tester

Portable measurement of everything from metal to rubber and plastic

Vickers Hardness Testing Machine Series

Wide range of test force available between 0.4903 mN and 490.3 N

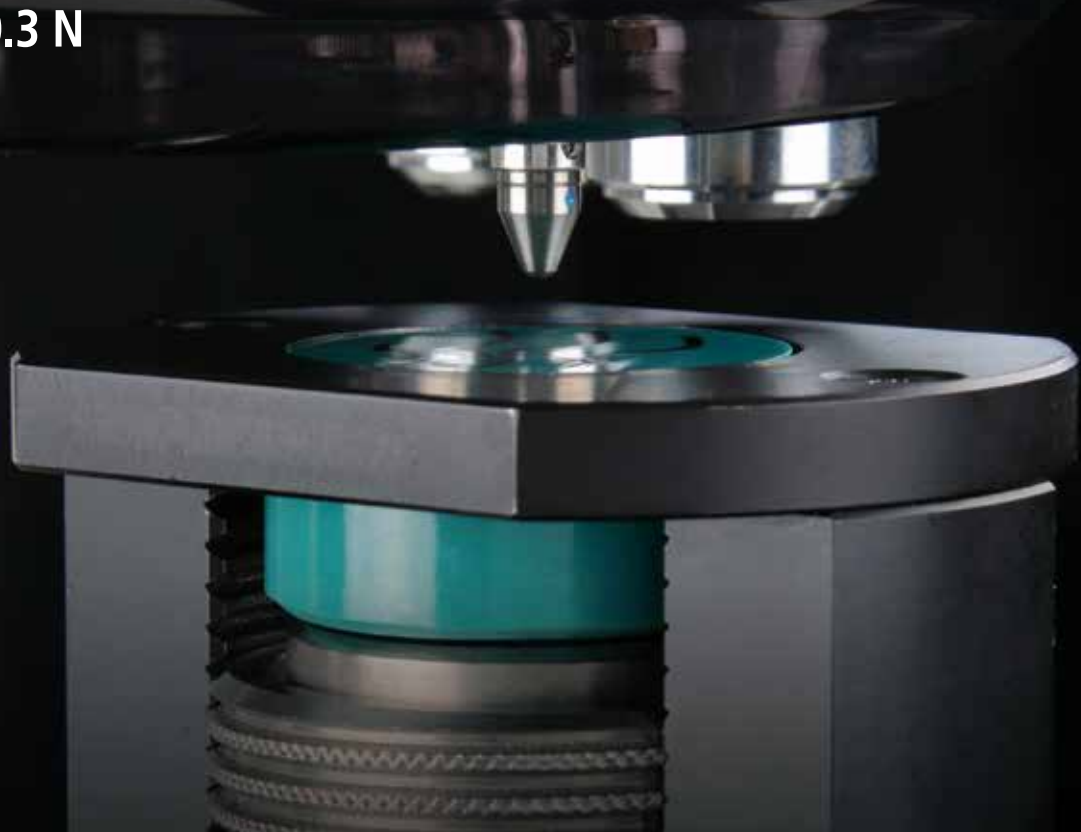

Micro Vickers hardness testing machines

Advanced model HM-200 Series

HM



Smart model
HM-100 Series



HM-200 Series: [Page 8](#)

Test force: **0.4903 to 19610** mN



HM-102

HM-100 Series: [Page 11](#)

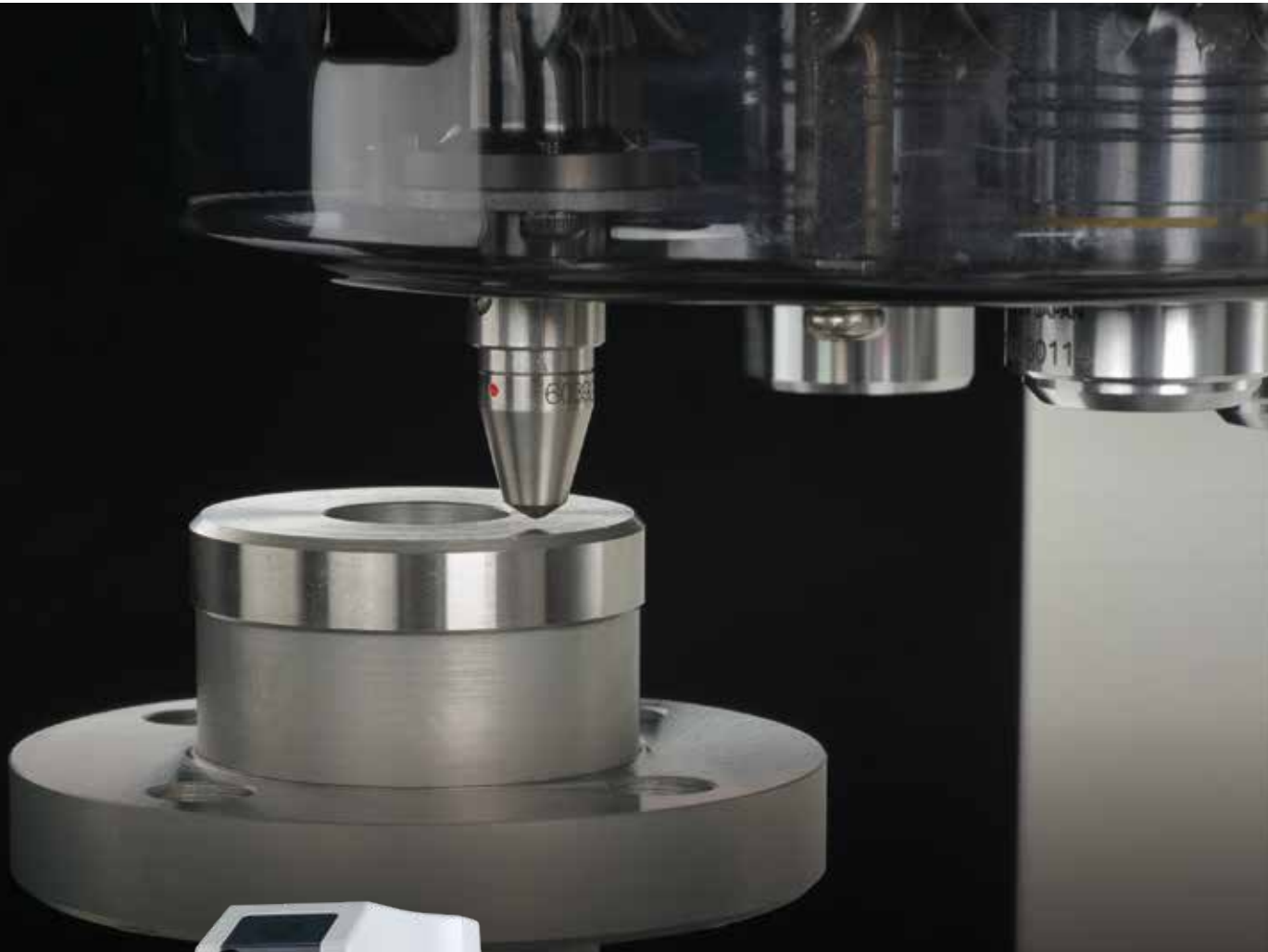

Vickers hardness testing machines

Advanced model HV-100 Series

HV 

HV-100 Series: [Page 12](#)

Test force: **2.942 to 490.3 N**

Advanced model

Micro Vickers hardness testing machines HM-200 Series

Adopts an electromagnetic force (force motor) load mechanism.
Freely select different test forces.
Four types of system (A to D) available for different purposes.



An online system to monitor the operational and mechanical statuses of measuring machines. This allows you to grasp the state of a process flow from the operational status of measuring machines within a production process.

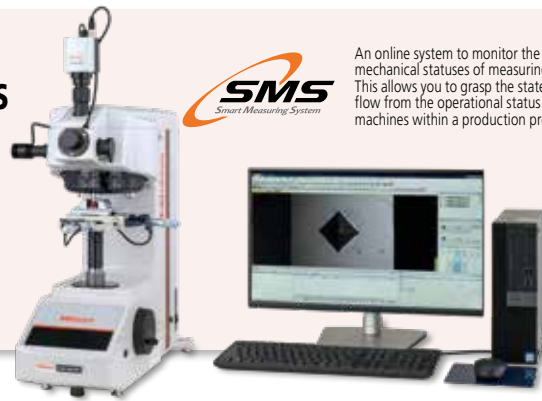

System A

Micro Vickers hardness testing machines HM-210A/HM-220A

All-in-one model with simple touch-panel operation

Features

- Touch-panel operation (Including test force conversion)
- Measurement of indentation dimensions using a measuring microscope
- Positioning using a manual XY stage



USB Interface enables use of removable data storage devices.

Note: Camera and monitor are optional accessories.

System B

Micro Vickers hardness testing machines HM-210B/HM-220B

Automatic dimensions by AVPAK-10/20 eliminates indentation measurement errors.

Features

- Operated using AVPAK-10/20 (Including test force conversion)
- Automatic indentation reading
- Positioning using a manual XY stage

System C

Micro Vickers hardness testing machines HM-210C/HM-220C

Improves work efficiency for multi-point testing

Features

- Operated using AVPAK-10/20 (Including test force conversion)
- Automatic indentation reading
- Automatic positioning with motorized XY stage

System D

Micro Vickers hardness testing machines HM-210D/HM-220D

Top-end model with autofocus

Features

- Operated using AVPAK-10/20 (Including test force conversion)
- Automatic indentation reading
- Automatic positioning with motorized XY stage
- Autofocusing

Note: The AVPAK-20 software package is not for use within, or export to, the United States of America. The AVPAK-10 software package is for the United States of America.

Refer to page 10 for details of each system.

System configuration	System A	System B	System C	System D
Testing action	Single point	Single point	Programmed multi-point	Programmed multi-point
Measuring indentations	Measuring microscope	Automatic (AVPAK-10/20)	Automatic (AVPAK-10/20)	Automatic (AVPAK-10/20)
Camera (for observing and measuring indentations)	CMOS, 1,230,000 pixels*1	Color, 3 million pixels	Color, 3 million pixels	Color, 3 million pixels
Test-point positioning	Manual XY stage*2	Manual XY stage*2	Motorized XY stage	Motorized XY stage
Focusing	Manual	Manual	Manual	Auto
Remote box	—	—	Motorized XY stage/Turret	Motorized XY stage/Turret
Operating the main unit	Touch panel	PC (AVPAK-10/20)	PC (AVPAK-10/20)	PC (AVPAK-10/20)

*1 When a TV camera unit is used (pixel count of the camera itself: 1,280,000)

*2 Manual XY stage (optional) can be supplied.

Objective lens specifications for HM-210/220

Item	Specification					
Model No.	MH Plan 2X	MH Plan 5X	MH Plan 10X	MH Plan 20X	MH Plan 50X	MH Plan 100X
Magnification	2X	5X	10X	20X	50X	100X
Working distance	6.0 mm	27.0 mm	11.8 mm	5.2 mm	2.5 mm	1.5 mm
Operation guarantee	Observation	Observation	Measurement/Observation	Measurement/Observation	Measurement/Observation	Measurement/Observation

AVPAK-10/20 software for controlling for Systems B/C/D

AVPAK-10/20 software for controlling Systems B, C and D allow seamless handling such as screen layout for control, testing status and result display.

Note: The **AVPAK-20** software package is not for use within, or export to, the United States of America.
The **AVPAK-10** software package is for the United States of America.

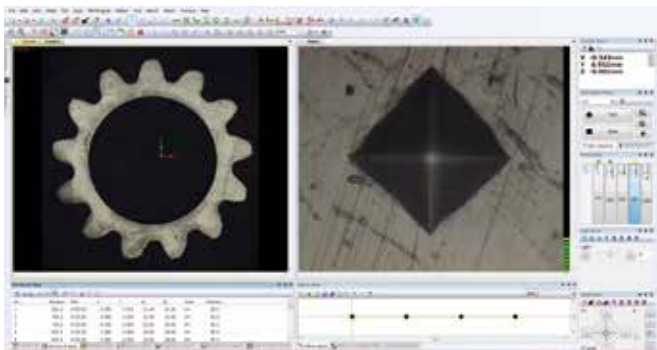

Refer to page 38 for details of the AVPAK.

Touch-panel display for System A

Easy-to-understand graphic display enables intuitive operation. Functions for converting values and compensating for curved surfaces, as well as a test condition guiding function are all provided as standard features. (Installed in the System A main unit)



Refer to page 42 for details of the Touch-panel.

Specifications: TV camera unit

System A

Item	Specification
Order No.	810-456-20 ^{*1} 810-454-20 ^{*2}
Camera	Imaging device: 1/3.2-inch CMOS (1,230,000 pixels)
Color LED screen magnification	When using a 10X objective lens: Approx. 200X
	When using a 50X objective lens: Approx. 1000X
	When using a 100X objective lens: Approx. 2000X
Color LED monitor	Power supply: 100-230 V AC, 50/60 Hz
	Power consumption: DC 12 V / 1.0 A: 9 W
	Screen size: 8 inch
	External dimensions: 202 (W) × 29.2 (D) × 175.8 (H) mm Mass: 1.7 kg

*1 Factory-installed options

*2 Units separately available. They need to be assembled and adjusted by field service engineers.

Specifications: Manual stage unit

Systems A and B

Item	Specification	
Order No.	810-420	810-423
Type	Manual XY 25×25	Manual XY 50×50
XY range	25×25 mm	50×50 mm
Table size	100×100 mm	130×130 mm
Minimum display unit	0.001 mm	
Dimensions	221 (W) × 221 (D) × 37 (H) mm	305 (W) × 305 (D) × 49 (H) mm
Mass	2.5 kg	6.6 kg

Specifications: Motorized stage unit

Systems C and D

Item	Specification	
Order No.	810-461-10	810-462-10
Type	Motorized XY 50×50	Motorized XY 100×100
Motorized XY stage		
XY range	50×50 mm	100×100 mm
Table size	130×130 mm	130×165 mm
Repeatability	2 μm	
Max. drive speed	25 mm/s	
Dimensions	242.5 (W) × 242.5 (D) × 55 (H) mm	299.5 (W) × 299.5 (D) × 55 (H) mm
Mass	5 kg	6.2 kg
Control unit		
Power consumption	67 W	
Dimensions	300 (W) × 290 (D) × 92 (H) mm	
Mass	4.5 kg	

Specifications: Motorized auto focus stage unit

System D

Item	Specification
Order No.	810-465
Table size	140×130 mm
Repeatability	0.2 μm
Dimensions	250 (W) × 132 (D) × 48 (H) mm
Mass	3 kg

System configuration for HM-210/220

Parameter	Item	System A	System B	System C	System D	Details	Notes
Main unit	HM-210 manual model main unit	●	—	—	—	Camera, 10X lens, 50X lens, etc.	
	HM-220 manual model main unit	●	—	—	—	Camera, 10X lens, 50X lens, etc.	
	HM-210 system model main unit	—	●	●	●	10X lens, 50X lens	No measuring microscope, no touch panel
	HM-220 system model main unit	—	●	●	●	10X lens, 50X lens	No measuring microscope, no touch panel
Stage	Motorized XY stage unit 50×50 mm	—	—	●	●		
	Motorized XY stage unit 100×100 mm	—	—	●	●		
	Manual XY stage unit 25×25 mm	●	●	—	—		
	Manual XY stage unit 50×50 mm	●	●	—	—		
Others	AF stage unit	—	—	—	●		
	AVPAK-10 AVPAK-20	—	●	●	●		Available overseas except the United States

●: One of each type must be selected from the choice offered —: Cannot be selected △: Contact Mitutoyo Sales Dept.

Specifications

Model		HM-210				HM-220							
Display unit		metric		inch/mm		metric		inch/mm		metric			
Operation		Manual		Manual		System		Manual		System			
Applicable standards		JIS B7725/ISO 6507-2											
Testable hardness		Vickers hardness (HV)/Knoop hardness (HK)/Fracture toughness (Kc)											
Test force		mN	(gf)	mN	(gf)	mN	(gf)	mN	(gf)	mN	(gf)	mN	(gf)
		98.07	(10)	1961	(200)	0.4903	(0.05)	9.807	(1)	196.1	(20)	2942	(300)
		196.1	(20)	2942	(300)	0.9807	(0.1)	19.61	(2)	294.2	(30)	4903	(500)
		294.2	(30)	4903	(500)	1.961	(0.2)	29.24	(3)	490.3	(50)	9807	(1000)
		490.3	(50)	9807	(1000)	2.942	(0.3)	49.03	(5)	980.7	(100)	19610	(2000)
		980.7	(100)			4.903	(0.5)	98.07	(10)	1961	(200)		
		Variable test force, setting of one model can be saved (Initial setting: HV0.025).											
Indenter approach speed		Fixed at 60 μm/s				HV0.03 or less: Variable between 2 and 60 μm/s. Can be set in 1 μm/s increments. HV0.031 or greater: Fixed at 60 μm/s							
Specimen	Maximum dimensions	Depth: 160 mm Height: 133 mm (Manual XY stage unit 25 mm)/72 mm (Motorized XY stage unit 100 mm+AF stage)											
	Max. loading capacity	System A, B: 3 kg System C: 7 kg System D: 4 kg											
Optical section	Optical system	Infinitely corrected optical system, 4-port objective lens switching method											
	Illumination	Light source	White LED										
		Aperture diaphragm	Variable										
	Standard objective lens	Lens	MH Plan 10X MH Plan 50X										
		Working distance	11.8 mm 2.5 mm										
Measuring microscope (Ocular)	System A: Real field of view: ø0.28 mm (maximum range: 0.14 mm) System B, C, D: Imaging range: 0.118 (H) mm×0.089 (V) mm												
Mechanism	Test force loading time	System A: Length-measuring microscope with integrated encoder and eyepiece (10X) System B, C, D: Factory-installed options											
	Test time	Test force loading time	1 to 99 s Can be set in 1 s increments.										
		Test force duration time	0 to 999 s Can be set in 1 s increments.										
		Test force unloading time	1 to 99 s Can be set in 1 s increments.										
	Loading device	Test force control	Electromagnetic (voice coil)										
Test force switching		System A: Can be selected from touch panel System B, C, D: Can be selected by AVPAK-10/20											
Turret	Drive method	Motor drive (Can be operated by manual)											
	Operation method	System A: Touch panel System B: AVPAK-10/20 System C/D: AVPAK-10/20 and Remote Control Box											
Number of turret ports	Indenter shaft unit: Up to two can be installed (including the standard Vickers indenter shaft unit already installed); Objective lens unit: Up to four can be installed (including the standard 10X, 50X objective lens already installed)												
Data output		RS-232C, Digimatic (can be used in only System A), USB2.0/Type A (only mounted in System A for USB memory), USB2.0/Type B (for PC communication)											
Power supply/Power consumption		AC 100 V 50/60 Hz 31 W (for HM-210 manual model main unit) 44 W (for HM-220 manual model main unit) 30 W (for HM-210 system model main unit) 43 W (for HM-220 system model main unit)											
Maximum specimen dimensions/Maximum load capacity	System A	Approx. 315 (W) ×671 (D) ×595 (H) mm											
	System B, C, D	Approx. 315 (W) ×586 (D) ×741 (H) mm											
Mass	Common for all system	38.5 kg (Manual model main unit) 37.4 kg (System model main unit)											

Note: The AVPAK-20 software package is not for use within, or export to, the United States of America. The AVPAK-10 software package is for the United States of America.

Standard accessories for HM-200 Series

Order No.	Item	Specification/Remarks
19BAA058	Diamond indenter	Vickers indenter for HM-210
19BAA059	Diamond indenter	Vickers indenter for HM-220
—	Hardness test block	700 HV 0.3 25 mm (diameter) ×6 mm (thickness)
—	Indenter shaft unit	With Vickers indenter
—	Objective lens unit 10X	With objective lens 10X
—	Objective lens unit 50X	With objective lens 50X
19BAA133	Spacer	Material: Bakelite 11 (W) ×42 (D) ×13 (H) mm
11AAB405	Extension shaft	For elevation shaft: 38 mm With two set screws
11AAB406	Extension shaft	For elevation shaft: 76 mm With two set screws

Order No.	Item	Specification/Remarks
12BAM841	Vinyl cover	For the hardness testing machine main unit
—	Tool kit	
—	User's manual	
—	Configuration disc	For System B, C, D
—	Accessory case	
—	Inspection certificate	In both Japanese and English for the tester
—	Inspection certificate for test piece	In both Japanese and English for test piece
—	Warranty card	In both Japanese and English

Smart model

Micro Vickers hardness testing machines HM-100 Series

The ideal series for Vickers hardness testing at the microscopic scale. Basic smart machines with the minimum requirement of functions for hardness testing. Three types are available: an analog model (**HM-101**) and digital models (**HM-102/103**).



HM-101



HM-102



HM-103

Specifications

Model	HM-101	HM-102	HM-103
Applicable standards	JIS B7725/ISO 6507-2		
Testable hardness	Vickers hardness (HV)/Knoop hardness (HK)		
Test force	mN	98.07 245.2 490.3 980.7 1961 2942 4903 9807	
	(gf)	(10) (25) (50) (100) (200) (300) (500) (1000)	
Test force control	Auto (load, duration, unload)		
Test force duration time	5 to 30 s (Arbitrary setting)	5 to 60 s	
Indenter approach speed	Approx. 60 μm/s (Approx. 50 μm/s)		
Specimen dimensions	Height: 95 mm, Depth: 150 mm		
Optical path	Measurement path/exposure path (Optical path split method)		
Objective lens	10X (For observation), 50X (For measurement)	10X, 50X (Measurement available with both lenses)	
Minimum display	0.2 μm	0.1 μm	
Maximum measurement length	Objective lens 50X: 140 μm	Objective lens 10X: 700 μm Objective lens 50X: 140 μm	Objective lens 10X: 500 (V) × 650 (H) μm Objective lens 50X: 100 (V) × 130 (H) μm
Manual XY stage	With analog micrometer head, Minimum graduation 10 μm		
Table size	100×100 mm		
Stage XY range	25×25 mm		
Measurement magnification calibrator	—	Installed	
Data processing function	—	Indentation diagonal length Hardness value Pass/failure decision function	
TV device Camera (1/3 inch) Monitor (8 inch monochrome)	—	—	Standard accessory
Turret switch	Manual		
External connection interface	—	Digimatic, RS-232C, Centronics	
External dimensions	Main unit: Approx. 380 (W) × 600 (D) × 590 (H) mm		
Mass	Main unit: 42 kg		
Power supply/ Power consumption	AC 100 V±10% (AC 120 V, AC 220 V, AC 240 V according to the factory shipped setting) HM-101, 102: 60 VA or less HM-103: Approx. 90 VA or less		

Note1: An optional Knoop indenter is required for Knoop hardness measurement.

Note2: **HM-102/103** operation panel external dimensions: 165 (W) × 260 (D) × 105 (H) mm, 1.5 kg

Note3: **HM-103** TV unit monitor external dimension: 232 (W) × 227 (D) × 426 (H) mm, mass: 4.4 kg

Standard accessories

Vickers indenter	19BAA058	1
Objective lenses	10X: 810-617 50X: 810-619	1
Fine adjustment table	810-011	1
Standard vise	810-016 Jaw opening: 51 mm	1
Hardness test block	700 HV 0.3 ø25 mm	1
Power code	One of any of the following: 02ZAA000 Order No. suffix: C and No suffix For PSE 02ZAA010 Order No. suffix: A For UL/CSA 02ZAA020 Order No. suffix: D For CEE 02ZAA030 Order No. suffix: E For BS 02ZAA040 Order No. suffix: DC For CCC 02ZAA050 Order No. suffix: K For KC	1
Tool kit	—	1
Accessory box	—	1
User's manual	—	1

Note: Weights and loading shaft are included in the accessory box as standard accessories and need to be attached to the main unit during assembly.

Advanced model

Vickers hardness testing machines HV-100 Series

Advanced model for carrying out not only Vickers hardness tests, but also Knoop, Brinell and Kc fracture toughness measurement. Choose from four types of system.



An online system to monitor the operational and mechanical statuses of measuring machines. This allows you to grasp the state of a process flow from the operational status of measuring machines within a production process.

System A

Vickers hardness testing machines HV-110A/HV-120A

All-in-one model with simple touch-panel operation

Features

- Touch-panel operation (Including test force conversion)
- Measurement of indentation dimensions using a measuring microscope
- Positioning using a manual XY stage (optional)



USB Interface enables use of removable data storage devices.

Note: Camera and monitor are optional accessories.

Refer to page 14 for details of each system.

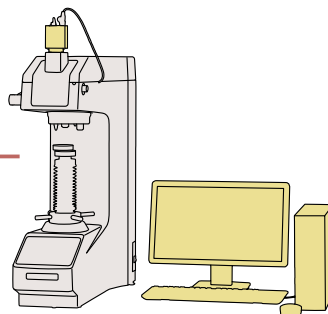

System B

Vickers hardness testing machines HV-110B/HV-120B

Automatic dimensions by AVPAK-10/20 eliminates indentation measurement errors.

Features

- Operated using AVPAK-10/20 (Including test force conversion)
- Automatic measurement of indentations
- Positioning using a manual XY stage (optional)

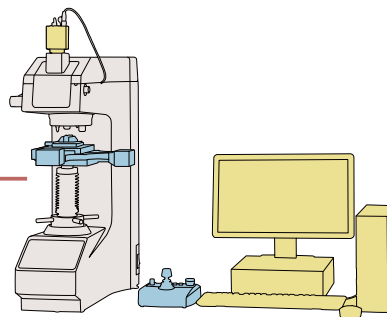

System C

Vickers hardness testing machines HV-110C/HV-120C

Improves work efficiency for multi-point testing

Features

- Operated using AVPAK-10/20 (Including test force conversion)
- Automatic indentation reading
- Automatic positioning with motorized XY stage

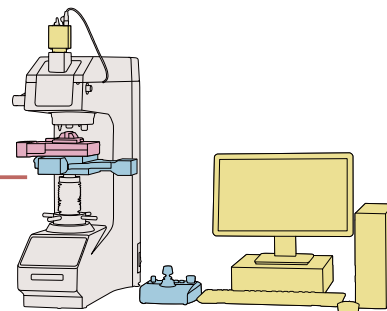

System D

Vickers hardness testing machines HV-110D/HV-120D

Top-end model with autofocus

Features

- Operated using AVPAK-10/20 (Including test force conversion)
- Automatic indentation reading
- Automatic positioning with motorized XY stage
- Autofocusing

Note: The AVPAK-20 software package is not for use within, or export to, the United States of America. The AVPAK-10 software package is for the United States of America.

System configuration	System A	System B	System C	System D
Testing action	Single point	Single point	Programmed multi-point	Programmed multi-point
Measuring indentations	Measuring microscope	Automatic (AVPAK-10/20)	Automatic (AVPAK-10/20)	Automatic (AVPAK-10/20)
Camera (for observing and measuring indentations)	CMOS, 1,230,000 pixels*1	Color, 3 million pixels	Color, 3 million pixels	Color, 3 million pixels
Test-point positioning	Manual XY stage*2	Manual XY stage*2	Motorized XY stage	Motorized XY stage
Focusing	Manual	Manual	Manual	Auto
Remote box	—	—	Motorized XY stage/Turret	Motorized XY stage/Turret
Operating the main unit	Touch panel	PC (AVPAK-10/20)	PC (AVPAK-10/20)	PC (AVPAK-10/20)

*1 When a TV camera unit is used (pixel count of the camera itself: 1,280,000)
 *2 Manual XY stage (optional) can be supplied.

Objective lens specifications for HV-110/120

Item	Specification					
Model No.	MH Plan 2X	MH Plan 5X	MH Plan 10X	MH Plan 20X	MH Plan 50X	MH Plan 100X
Magnification	2X	5X	10X	20X	50X	100X
Working distance	6.0 mm	27.0 mm	11.8 mm	5.2 mm	2.5 mm	1.5 mm
Operation guarantee	Observation	Observation	Observation/Measurement	Observation/Measurement	Observation/Measurement	Observation/Measurement

AVPAK-10/20 software for controlling for Systems B/C/D

AVPAK-10/20 software for controlling Systems B, C and D allow seamless handling such as screen layout for control, testing status and result display.

Note: The **AVPAK-20** software package is not for use within, or export to, the United States of America.
The **AVPAK-10** software package is for the United States of America.

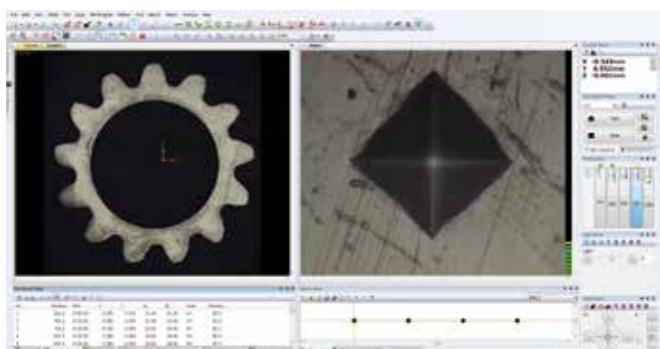

Refer to page 38 for details of the AVPAK.

Touch-panel display for System A

Easy-to-understand graphic display enables intuitive operation. Functions for converting values and compensating for curved surfaces, as well as a test condition guiding function are all provided as standard features. (Installed in the System A main unit)



Refer to page 42 for details of the Touch-panel.

Specifications: TV camera unit

System A

Item	Specification
Order No.	810-456-20 ^{*1} 810-454-20 ^{*2}
Camera	Imaging device: 1/3.2-inch CMOS (1,230,000 pixels)
Color LED screen magnification	When using a 10X objective lens: Approx. 200X
	When using a 50X objective lens: Approx. 1000X
	When using a 100X objective lens: Approx. 2000X
Color LED monitor	Power supply: 100-230 V AC, 50/60 Hz
	Power consumption: DC 12 V / 1.0 A: 9 W
	Screen size: 8 inch
	External dimensions: 202 (W) × 29.2 (D) × 175.8 (H) mm Mass: 1.7 kg

*1 Factory-installed options

*2 Units separately available. They need to be assembled and adjusted by field service engineers.

Specifications: Manual stage unit

Systems A and B

Item	Specification	
Order No.	810-420	810-423
Type	Manual XY 25×25	Manual XY 50×50
XY range	25×25 mm	50×50 mm
Table size	100×100 mm	130×130 mm
Minimum display unit	0.001 mm	
Dimensions	221 (W) × 221 (D) × 37 (H) mm	305 (W) × 305 (D) × 49 (H) mm
Mass	2.5 kg	6.6 kg

Specifications: Motorized stage unit

Systems C and D

Item	Specification	
Order No.	810-461-10	810-462-10
Type	Motorized XY 50×50	Motorized XY 100×100
Motorized XY stage		
XY range	50×50 mm	100×100 mm
Table size	130×130 mm	130×165 mm
Repeatability	2 μm	
Max. drive speed	25 mm/s	
Dimensions	242.5 (W) × 242.5 (D) × 55 (H) mm	299.5 (W) × 299.5 (D) × 55 (H) mm
Mass	5 kg	6.2 kg
Control unit		
Power consumption	67 W	
Dimensions	300 (W) × 290 (D) × 92 (H) mm	
Mass	4.5 kg	

Specifications: Motorized auto focus stage unit

System D

Item	Specification
Order No.	810-465
Table size	140×130 mm
Repeatability	0.2 μm
Dimensions	250 (W) × 132 (D) × 48 (H) mm
Mass	3 kg

System configuration for HV-110/120

Parameter	Item	System A	System B	System C	System D	Details	Notes
Main unit	HV-110 manual model main unit	●	—	—	—	Camera, 10X lens, etc.	
	HV-120 manual model main unit	●	—	—	—	Camera, 10X lens, etc.	
	HV-110 system model main unit	—	●	●	●	10X lens	No measuring microscope, no touch panel
	HV-120 system model main unit	—	●	●	●	10X lens	No measuring microscope, no touch panel
Stage	Motorized XY stage unit 50×50 mm	—	—	●	●		
	Motorized XY stage unit 100×100 mm	—	—	●	●		
	Manual XY stage unit 50×50 mm	○	○	—	—		
	Round table	○	○	—	—	Outside diameter ø180 mm	
	Round table	○	○	—	—	Outside diameter ø250 mm	
Others	AF stage unit	—	—	—	●		
	AVPAK-10	—	●	●	●		
	AVPAK-20	—	●	●	●		Available overseas except the United States

○: Selectable ●: One of each type must be selected from the choice offered —: Cannot be selected △: Contact Mitutoyo Sales Dept.

Specifications

Model		HV-110				HV-120				
Display unit		metric		inch/mm		metric		inch/mm		
Operation		Manual		Manual		System		System		
Applicable standards		JIS B7725/ISO 6507-2								
Testable hardness		Vickers hardness (HV)/Knoop hardness (HK)/Fracture toughness (Kc)/Brinell hardness (HB)								
Test force		N	(kgf)	N	(kgf)	N	(kgf)	N	(kgf)	
		9.807	(1)	196.1	(20)	2.942	(0.3)	98.07	(10)	
		19.61	(2)	294.2	(30)	4.903	(0.5)	196.1	(20)	
		29.42	(3)	490.3	(50)	9.807	(1)	294.2	(30)	
		49.03	(5)			24.51	(2.5)			
	98.07	(10)			49.03	(5)				
Indenter approach speed		60 µm/s, 150 µm/s								
Specimen	Maximum dimensions	Depth: 170 mm Height: 210 mm (Manual main unit and flat anvil)/132 mm (System main unit+motorized XY stage unit 50 mm+AF stage)								
	Max. loading capacity	System A, B: 20 kg System C: 7 kg System D: 4 kg								
Optical section	Optical system		Infinitely corrected optical system, 3-port objective lens switching method							
	Illumination	Light source	White LED							
		Aperture diaphragm	Variable							
	Standard objective lens	Lens	MH Plan 10X							
		Working distance	11.8 mm							
Measuring microscope (Ocular)	Real field of view and imaging range	System A: Real field of view: 1.4 mm (When the length-measuring microscope is used) System B, C, D: Imaging range: 0.590 (H) mm×0.443 (V) mm								
Mechanism	Test time	Test force loading time	5 to 999 s Can be set in 1 s increments.							
		Test force control	Electromagnetic (voice coil)							
	Loading device	Test force switching	System A: Can be selected from touch panel System B, C, D: Can be selected by AVPAK-10/20							
		Drive method	Motor drive (Can be operated by manual)							
	Turret	Operation method	System A: Touch panel System B: AVPAK-10/20 System C/D: AVPAK-10/20 and Remote Control Box							
Number of turret ports		Indenter shaft unit: Up to one can be installed (including the standard Vickers indenter shaft unit already installed); Objective lens unit: Up to three can be installed (including the standard 10X objective lens already installed)								
Data output		RS-232C, Digimatic, USB2.0/Type A (only mounted in system A for USB memory), USB2.0/Type B (for PC communication)								
Power supply/Power consumption		AC100 V 50/60 Hz (Manual main unit: 24 W System main unit: 22 W)								
Maximum specimen dimensions/Maximum load capacity	System A	Approx. 307 (W) ×696 (D) ×781 (H) mm								
	System B, C, D	Approx. 307 (W) ×627 (D) ×875 (H) mm								
Mass	Common for all system	HV-110: 60 kg (Manual model main unit), 59 kg (System model main unit)				HV-120: 58 kg (Manual model main unit), 57 kg (System model main unit)				

Note: The AVPAK-20 software package is not for use within, or export to, the United States of America. The AVPAK-10 software package is for the United States of America.

Standard accessories for HV-100 Series

Order No.	Item	Specification / Remarks
19BAA060	Diamond indenter	
—	Objective lens 10X	
—	Hardness test block	700 HV 10 64 mm (diameter) ×15 mm (thickness)
810-039	Flat anvil	Outside diameter ø64 mm
383876	Vinyl cover	
12BAL402	Protective sheet	For main unit
—	Level	

Order No.	Item	Specification / Remarks
—	Tool kit	
—	User's manual	
—	Configuration disc	For System B, C, D
—	Accessory case	
—	Inspection certificate for test piece	In both Japanese and English for test piece
—	Warranty card	In both Japanese and English

Combination for Brinell test correspondence table and optional accessories

	Test force / diameter	30	10	5	2.5	1
HV-110	Indenter	HBW 1/30	HBW 1/10	HBW 1/5	HBW 1/2.5	HBW 1/1
	ø1 mm (11AAD469)	○	○	○	Brinell weight (0.5) 11AAC697	○
	Indenter	HBW 2.5/187.5	HBW 2.5/62.5	HBW 2.5/31.25	HBW 2.5/15.625	HBW 2.5/6.25
	ø2.5 mm (11AAD470)	—	Brinell weight (12.5) 11AAC700	Brinell weight (1.25) 11AAC698	Brinell weight (5.625) 11AAC699	Brinell weight (1.25) 11AAC698
HV-120	Indenter	HBW 1/30	HBW 1/10	HBW 1/5	HBW 1/2.5	HBW 1/1
	ø1 mm (11AAD469)	○	○	○	○	○
	Indenter	HBW 2.5/187.5	HBW 2.5/62.5	HBW 2.5/31.25	HBW 2.5/15.625	HBW 2.5/6.25
	ø2.5 mm (11AAD470)	—	—	Brinell weight (1.25) 11AAC698	Brinell weight (5.625) 11AAC699	Brinell weight (1.25) 11AAC698

○: Compatible with only when adding an indenter. —: Not compatible

Optional accessories for Micro Vickers/Vickers hardness testing machines

Item	Order No.	Description	HM-210A	HM-220A	HM-210B	HM-220B	HM-210C	HM-220C	HM-210D	HM-220D	HM-101/102/103	HV-110A/HV-120A	HV-110B/HV-120B	HV-110C/HV-120C	HV-110D/HV-120D	
Measuring microscope (connection)	11AAE777				●	●	●	●	●	●						Factory-installed options
	11AAE677			●	●	●	●	●	●	●						They need to be assembled and adjusted by field service engineers.
	11AAE778											●	●	●		Factory-installed options
	11AAE678											●	●	●		They need to be assembled and adjusted by field service engineers.
TV camera unit	With monitor	810-456-20	●	●	●	●	●	●	●	●	●	●	●	●	●	Factory-installed options
		810-454-20	●	●	●	●	●	●	●	●	●	●	●	●	●	They need to be assembled and adjusted by field service engineers.
	Without monitor	810-457-20	●	●	●	●	●	●	●	●	●	●	●	●	●	Factory-installed options
		810-455-20	●	●	●	●	●	●	●	●	●	●	●	●	●	They need to be assembled and adjusted by field service engineers.
Objective lens unit	11AAE765	2X	●	●	●	●	●	●	●	●						Factory-installed options Select up to two types of objective lens unit
	11AAE766	5X	●	●	●	●	●	●	●	●						
	11AAE768	20X	●	●	●	●	●	●	●	●						
	11AAE769	100X	●	●	●	●	●	●	●	●						They need to be assembled and adjusted by field service engineers. Select up to two types of objective lens unit
	11AAE665	2X	●	●	●	●	●	●	●	●						
	11AAE666	5X	●	●	●	●	●	●	●	●						
	11AAE668	20X	●	●	●	●	●	●	●	●						
11AAE669	100X	●	●	●	●	●	●	●	●							
Objective lens	810-616	5X								●						An objective lens cannot be additionally to mounted. They need to change for Factory-installed options or they need to be assembled and adjusted by field service engineers.
	810-618	20X								●						
	810-620	100X								●						
	11AAE772	2X									●	●	●	●		Factory-installed options Select up to two types of objective lens unit
	11AAE773	5X									●	●	●	●		
	11AAE774	20X									●	●	●	●		
	11AAE775	50X									●	●	●	●		
	11AAE776	100X									●	●	●	●		They need to be assembled and adjusted by field service engineers. Select up to two types of objective lens unit
	11AAE672	2X									●	●	●	●		
	11AAE673	5X									●	●	●	●		
	11AAE674	20X									●	●	●	●		
11AAE675	50X									●	●	●	●			
11AAE676	100X									●	●	●	●			
Indenter for Knoop hardness test	19BAA061	For standard strength test	●	●	●	●	●	●	●	●						Color-coded: Red line
	19BAA062	For low strength test		●	●	●	●	●	●	●						Color-coded: Blue line
	19BAA063	For standard strength test									●	●	●	●		
Indenter shaft unit for Knoop hardness test	11AAE770		●	●	●	●	●	●	●	●						With a Knoop indenter Factory-installed options
	11AAE771			●	●	●	●	●	●	●						
	11AAE670		●	●	●	●	●	●	●	●						With a Knoop indenter They need to be assembled and adjusted by field service engineers.
	11AAE671			●	●	●	●	●	●	●						
For Brinell hardness test	Indenter	11AAD469	ø1 mm								●	●	●	●		Carbide ball indenter
		11AAD470	ø2.5 mm								●	●	●	●		Carbide ball indenter
	Spare carbide ball	19BAA281	ø1 mm									●	●	●	●	Carbide ball indenter
		19BAA283	ø2.5 mm									●	●	●	●	Carbide ball indenter
Weight for Brinell hardness test	11AAC697	0.5 kgf									●	●	●	●		
	11AAC698	1.25 kgf									●	●	●	●		
	11AAC699	5.625 kgf									●	●	●	●		
	11AAC700	12.5 kgf									●	●	●	●		

Note: The factory-installed options are factory-assembled, before shipment, to a hardness testing machine ordered together with them.

Item	Order No.	Description	HM-210A	HM-220A	HM-210B	HM-220B	HM-210C	HM-220C	HM-210D	HM-220D	HM-101/102/103	HV-110A/HV-120A	HV-110B/HV-120B	HV-110C/HV-120C	HV-110D/HV-120D
Hardness standard block	19BAA010	40 HMV	●	●	●	●	●	●	●	●					
	19BAA001	100 HMV	●	●	●	●	●	●	●	●					
	19BAA002	200 HMV	●	●	●	●	●	●	●	●					
	19BAA003	300 HMV	●	●	●	●	●	●	●	●					
	19BAA004	400 HMV	●	●	●	●	●	●	●	●					
	19BAA005	500 HMV	●	●	●	●	●	●	●	●					
	19BAA006	600 HMV	●	●	●	●	●	●	●	●					
	19BAA007	700 HMV	●	●	●	●	●	●	●	●					
	19BAA008	800 HMV	●	●	●	●	●	●	●	●					
	19BAA009	900 HMV	●	●	●	●	●	●	●	●					
	19BAA011	200 HV									●	●	●	●	
	19BAA012	300 HV									●	●	●	●	
	19BAA013	400 HV									●	●	●	●	
	19BAA014	500 HV									●	●	●	●	
	19BAA015	600 HV									●	●	●	●	
	19BAA016	700 HV									●	●	●	●	
	19BAA017	800 HV									●	●	●	●	
	19BAA018	900 HV									●	●	●	●	

Hardness standard block for Micro Vickers hardness testing machines
An inspection certificate is supplied for HV0.01/HV0.1/HV1.

Hardness standard block for Vickers hardness testing machines
An inspection certificate is supplied for HV1/HV10.

Common applications

Item	Order No.	Description																	
			HM-210A	HM-220A	HM-210B	HM-220B	HM-210C	HM-220C	HM-210D	HM-220D	HM-101/102/103	HV-110A/HV-120A	HV-110B/HV-120B	HV-110C/HV-120C	HV-110D/HV-120D				
External output	264-505	Digimatic Mini-Processor DP-1VA LOGGER 	●	●									○	●					Note that a connection cable is not supplied with the DP-1VA LOGGER and must be ordered separately.
	936937	Connection cable (1 m) Type D	●	●										●					10-pin plain connector
	937387	Connection cable (1 m) Type E												○					6-pin round connector
	09EAA082	Printing paper																	For DP-1VA (10 rolls)
	02AZD810D	U-WAVE-R	●	●									○	●					
	02AZD730G	U-WAVE-T (IP67 type)	●	●									○	●					
	02AZD880G	U-WAVE-T buzzer type	●	●									○	●					
	02AZD790E	U-WAVE-T dedicated connection cable Type E												○					6-pin round connector
	02AZD790D	U-WAVE-T dedicated connection cable Type D	●	●										●					10-pin plain connector
	264-020	Input tool IT-020U	●	●									○	●					Applicable OS: Windows 10 (64 bit)
	06AFM380E	Input tool direct USB-ITN-E											○						
	06AFM380D	Input tool direct USB-ITN-D	●	●										●					
	11AAC236	EXPAK-06	●	●										●					Refer to page 50 for details.
	11AAC237	EXPAK-07 (for HM-102/103)												○					
	02NDB101D	MeasurLink® Real-Time Professional			●	●	●	●	●	●	●				●	●	●		

○: Except HM-101

Specimen fixtures







Note: Use the specimen fixtures below under a test force of 1 kgf/9.81 N only (except for resin mold specimen tables).

Item	Order No.	Description																	
			HM-210A	HM-220A	HM-210B	HM-220B	HM-210C	HM-220C	HM-210D	HM-220D	HM-101/102/103	HV-110A/HV-120A	HV-110B/HV-120B	HV-110C/HV-120C	HV-110D/HV-120D				
Specimen mounting jig	Sheet specimen table	810-013 	●	●	●	●			▲	▲	●								Prevents variations of hardness results due to flexure and wrinkling during measurement of sheets of thickness within 5 mm. (e.g. Scalpel blades, etc.)
	Thin specimen table (vertical type)	810-015-1 	●	●	●	●				●	●	●							Clamps pin-shaped specimens of 0.4 to 3.2 mm diameter or less in a chuck. (e.g. Wire of steel or copper, etc.)
	Thin specimen table (horizontal type)	810-014-1 	●	●	●	●			▲	▲	●								Holds a thin specimen of 0.4 to 3.2 mm diameter or less for measuring on a side face. (e.g. Wire, piano wire, etc.)
Tilting specimen table	810-019 		●	●	●	●	▲	▲	▲	▲	●								Levels the specimen measurement face to prevent variations of indentation shape, with an opening width of 37 mm, tilt angle of ±15°, and rotation angle of ±25°.
Sheet specimen table	810-085 		●	●	●	●	●	●	●	●	●								Enables securing of very thin or narrow specimens like foil or fine wire. (thickness within 3 mm and width within 56 mm)
Resin mold specimen tables	810-650-1	ø25.4±0.5 mm 																	Resin molds can easily be installed. Specimen height: 9 to 39 mm Test force conversion: supports up to 50 kgf
	810-650-2	ø30±0.5 mm	●	●	●	●	●	●	●	●	●	●	●	●	●	●	●	●	
	810-650-3	ø31.75±0.5 mm	●	●	●	●	●	●	●	●	●	●	●	●	●	●	●	●	
	810-650-4	ø38.1±0.5 mm	●	●	●	●	●	●	●	●	●	●	●	●	●	●	●	●	
Tabletop for resin mold specimen stand	810-650-5	ø40±0.5 mm																	Tabletop attached to resin mold specimen stand
	11BAF894	ø25.4±0.5 mm	●	●	●	●	●	●	●	●	●	●	●	●	●	●	●	●	
	11BAF895	ø30±0.5 mm	●	●	●	●	●	●	●	●	●	●	●	●	●	●	●	●	
	11BAF896	ø31.75±0.5 mm	●	●	●	●	●	●	●	●	●	●	●	●	●	●	●	●	
	11BAF897	ø38.1±0.5 mm	●	●	●	●	●	●	●	●	●	●	●	●	●	●	●	●	
11BAF898	ø40±0.5 mm	●	●	●	●	●	●	●	●	●	●	●	●	●	●	●	●	●	
Adjustable specimen table (Specimen thickness of 30 mm or less)	810-020 		▲	▲	▲	▲	▲	▲	▲	▲	●								Allows proper alignment of the sample surface and the indenter axis when parallelism of the sample is poor. It cannot be used with automatic hardness testing systems.



▲: There are protrusions from the specimen surface, so be careful when handling the indenter and lens.

Specimen fixtures

Note: Use the specimen fixtures below under a test force of 1 kgf/9.81 N only (except for round table, V-anvil, and vise).

Item	Order No.	Description	HM-210A	HM-220A	HM-210B	HM-220B	HM-210C	HM-220C	HM-210D	HM-220D	HM-101/102/103	HV-110A/HV-120A	HV-110B/HV-120B	HV-110C/HV-120C	HV-110D/HV-120D	
Rotary tilting specimen table	810-095		●	●	●	●	●	●	●	●						In cases where top and bottom surfaces of the specimen are not parallel, the tilting rotary specimen table's adjuster and standard accessory hand press can be used to make adjustments (adjustment range: ±3°) so the top surface of the specimen is perpendicular to the indenter shaft of the hardness testing machine. When attached to the testing machine, the specimen surface can be rotated 360° (in 2° increments). Height: 20 mm or more Diameter: 15 to 55 mm
Rotary table (Minimum graduation 1°)	810-018		●	●	●	●	●	●	●	●						The specimen fixed on the table can be rotated for convenient measurement.
Round table	810-037	(Diameter: 180 mm) 									●	●				
	810-038	(Diameter: 250 mm)														
V-anvil	810-040	V-anvil (large) 										●	●			Angle: 120°, Outside diameter: ø40 mm, Groove width: 30 mm For shaft (max. ø60 mm)
	810-041	V-anvil (small)														Angle: 90°, Outside diameter: ø40 mm, Groove width: 6 mm For shaft (max. ø8.4 mm)
Vise	810-016		●	●	●	●	●	●	●	●	●	●	●	●	●	Open width: 51 mm
	810-017		●	●	●	●	●	●	●	●	●	●	●	●	●	Open width: 100 mm

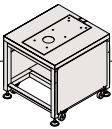
Other optional accessories

Item	Order No.	Description	HM-210A	HM-220A	HM-210B	HM-220B	HM-210C	HM-220C	HM-210D	HM-220D	HM-101/102/103	HV-110A/HV-120A	HV-110B/HV-120B	HV-110C/HV-120C	HV-110D/HV-120D	
Hardness calculation table (for Knoop)	19BAA270									●						Only HM-101
Calibration certificate			●	●	●	●	●	●	●	●	●	●	●	●		
System rack	998923				●	●	●	●	●			●	●	●		For PC
Stand for testing machine	11AAC702											●	●	●	●	Only for the testing machines 680 (W) × 680 (D) × 520 (H) mm
Vibration isolator	810-641		●	●	●	●	●	●	●	●						Only for the testing machines Spring vibration isolator with damper 690 (W) × 740 (D) × 700 (H) mm Maximum load: 60 kg
	11AAC719											●	●	●	●	Only for the testing machines Spring vibration isolator with damper 690 (W) × 740 (D) × 700 (H) mm Withstand load: 100 kg
S wing for vibration isolator. Provides a storage area.	810-644		●	●	●	●	●	●	●	●	●	●	●	●	●	For vibration isolator (810-640, 810-641, 810-642, 810-643) To be attached to a vibration isolator 740 (W) × 300 (D) × 228 (H) mm
Foot switch	937179T (Resin type) 12AAJ088 (Metal type)										●					Switch for starting hardness testing. With a series of test operations such as Ocular/footswitch/turret switch/vertical handle operation, the test machine can be operated without using touch-panel.
Table	02ATE760		●	●	●	●	●	●	●							1800 (W) × 900 (D) × 740 (H) mm

Rockwell Hardness Testing Machine Series

Choose from a wide lineup ranging from the smart model with simple function to the high-end Digimatic model featuring an electronically controlled loading mechanism.

HR 



HR-600 Series: [Page 22](#)



HR-530 Series: [Page 26](#)

HR-200/300/400 Series: [Page 30](#)

Rockwell hardness testing machine
HR-600 Series



An online system to monitor the operational and mechanical statuses of measuring machines. This allows you to grasp the state of a process flow from the operational status of measuring machines within a production process.

The **HR-600 Series** can measure and test large, heavy objects without cutting. Simply load and test. Testing can also be automated with an electrically powered X/Y table loader. Further automation can be implemented by linking with a transport or a signal tower.

New solution for improved throughput



HR-610A/620A

- Maximum specimen dimension/
Height: 250 mm, Depth: 220 mm

- Large, heavy objects can be measured and tested.
- Expansion can be made with an electrically powered X-axis table.
- Operation is simple thanks to a touch panel display.

HR-620B

- Maximum specimen dimension/
Height: 250 mm, Depth: 220 mm

- Electrically powered Y-axis table equipped as standard. (Can be expanded with an electrically powered X-axis table)
- Perform automatic Rockwell multi-point testing of multiple parts or workpieces.
- It is also possible to incorporate a fully automatic Rockwell hardness test system where even workpiece transport is automatic. (Linking with PLC requires the FORMEio software (sold separately).)



Scan the QR code to watch the video.

First Mitutoyo hardness testers with moving heads

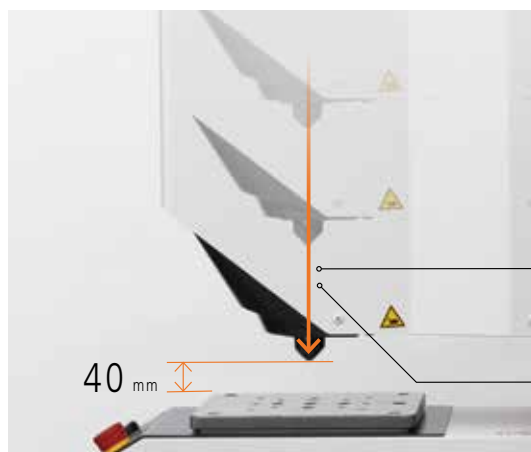

First Mitutoyo hardness testers ever to be equipped with moving heads (the head moves at a speed of 10 mm/s within a 210 mm range).

210 mm
Movement along Z axis [drive unit]

10 mm/s
Speed along Z axis [drive unit]

Large workpieces can be mounted easily



Large workpieces such as cylinder blocks can be mounted on the table as is. Testing of heavy workpieces weighing up to 100 kg is supported.



Maximum loading 100 kg
Depth (from indenter center) 220 mm

Supports testing of a wide range of workpiece, from metals to plastics

Crank shaft



Cylinder head



Cylinder block



Brake pads



Gear



Plastic parts

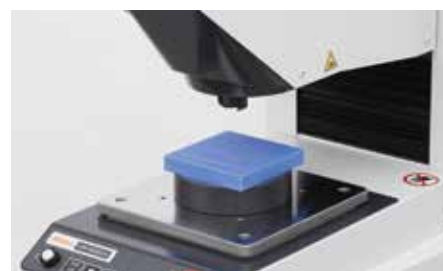

Feature-packed color touch panel



A touch screen that can toggle between different views enables excellent control of a rich palette of features.

Enables smooth and efficient measurements

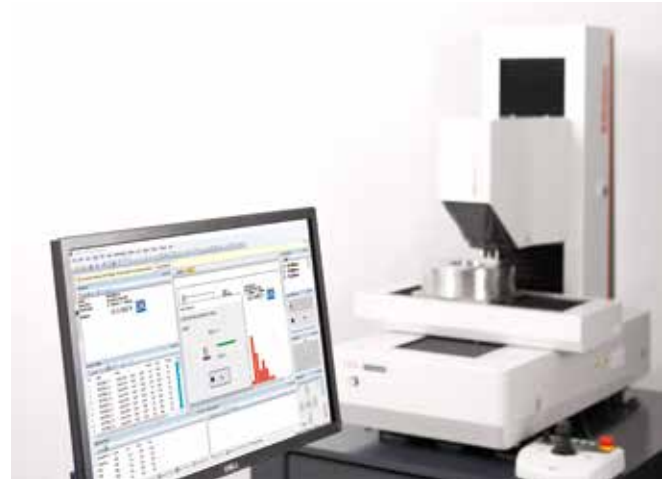

AVPAK, using part programs, enables automated multi-point testing.

Build a system that caters to the needs on the ground

By installing an X-axis stage (optional) on an **HR-620B** machine and creating a system that coordinates with robots, you can automate the testing procedure, from mounting workpieces to sorting them according to test results.

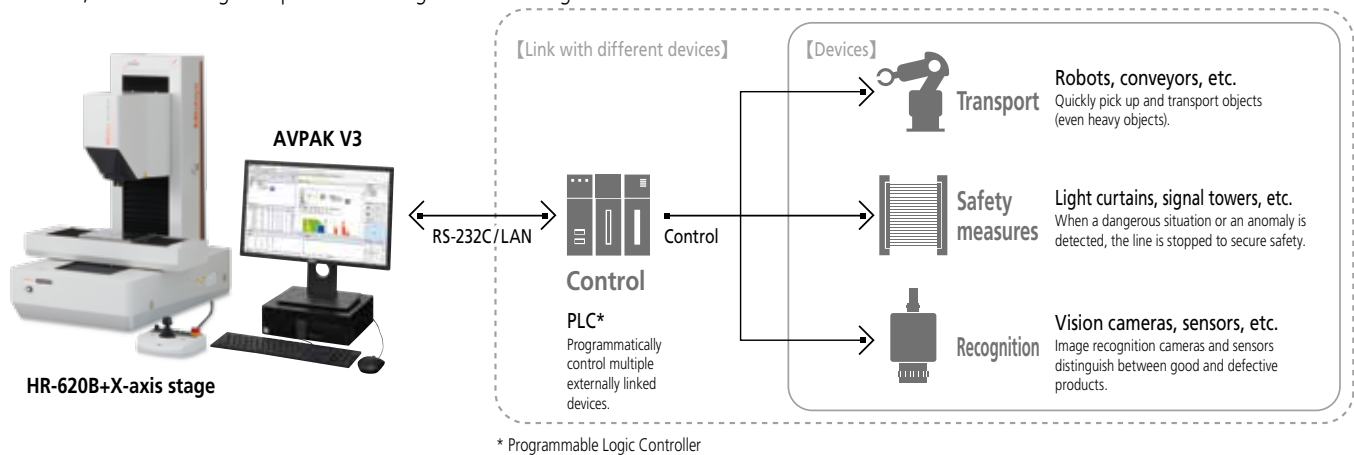

Applicable standards and test force

		HR-610A	HR-620A	HR-620B
Test methods/ Standard No.	Rockwell	JIS B7726:2017, ISO 6508-2:2015, ASTM E18-20		
	Brinell*	JIS B7724:2017, ISO 6506-2:2017, ASTM E10-18		
	Plastic	ISO 2039-1:2001		
	Indentation Brinell hardness	JIS K7202-2:2001, ISO 2039-2:1987, ASTM D785-08 [A&B]		
Initial test force N (kgf)	Indentation Vickers hardness	VDI/VDE 2616		
	Rockwell	VDI/VDE 2616		
	Plastic	98.07 (10)		
	Indentation Brinell hardness	29.42 (3)	98.07 (10)	9.807 (1)
Test force N (kgf)	Indentation Vickers hardness	9.807 (1)		
	Rockwell	147.1 (15)	294.2 (30)	441.3 (45)
	Brinell	49.03 (5) - 1839 (187.5)	588.4 (60)	980.7 (100)
	Plastic	588.4 (60) 980.7 (100) 1471 (150)		
Indentation Brinell hardness		612.9 (62.5)	1839 (187.5)	2452 (250)
	Indentation Vickers hardness	294.2 (30) 490.4 (50)		

* For Brinell hardness testing, an indenter (optional) and a measurement microscope are required. A measurement microscope should be prepared by customer.

Specifications

Model		HR-610A		HR-620A		HR-620B	
Unit (display unit)		metric		inch/mm		—	
Indenter type ^{*1}		1/16" Steel ball		1/16" Tungsten carbide ball		1/16" Steel ball	
Testable hardness		Rockwell hardness/Rockwell Superficial hardness/Brinell hardness/ Indentation Brinell hardness/Plastics hardness				Rockwell hardness/ Rockwell Superficial hardness/ Brinell hardness/ Indentation Brinell hardness/ Plastics hardness/ Indentation Vickers hardness	
Test force range		29.42 to 1839 N (3 to 187.5 kgf)		9.807 to 2452 N (1 to 250 kgf)			
Specimen height (Z-axis stroke)				40 to 250 mm			
Workpiece criteria	Minimum surface dimensions			18×4 mm or more			
	Minimum inner diameter of pipe-type workpiece			ø400 mm or more			
	Concave workpiece			R25 mm or more, Height 20 mm or less			
	Minimum outside diameter			ø20 mm or more			
Z-axis speed				Approx. 10 mm/s			
Maximum depth (from indenter center)				220 mm			
X-axis stroke				None (Option: 160 mm or 300 mm)			
Y-axis stroke				None		160 mm	
Maximum table loading				100 kg			
Display	Standard	Number of data displayed: 1, Hardness value, Scale, Test numbering, Hold time (Initial test force), Hold time (Total test force), Reading time, Hardness conversion, Judgment, Correction, Unit					
	Simple	Number of data displayed: 1, Hardness value, Scale, Judgment, Correction					
	List average/list	Number of data displayed: 5, Hardness value, Average hardness value, Hardness variation, Scale, Hardness conversion, Judgment, Correction					
	Multipoint	Depending on set test points, Hardness value, Scale, Test numbering, Judgment, Correction, Unit					
Calculation	GO/NG judgment function	Test results judged according to set maximum/minimum values					
	Conversion function	Converts obtained test results to another scale					
Correction functions	Curved surface compensation	Corrects results according to specimen shape (cylindrical, spherical, etc.)					
	User Shift correction	Corrects by increasing/decreasing value according to hardness value					
	Multipoint	Corrects based on the results of tests conducted on multiple standard blocks (Rockwell/superficial only)					
External output settings	Serial	For printer (RS-232C compliant) 1-ch					
	Digimatic	Digimatic interface outputs 1-ch					
	USB2.0	For USB memory/1-ch for PC communication					
Languages		Supports the following 15 languages Japanese, English, German, French, Italian, Spanish, Korean, Chinese (simplified/traditional), Turkish, Portuguese, Polish, Czech, Hungarian and Dutch					
Hardness value	Digital display	Max. 7-digit (including decimal point and sign)					
	Minimum reading	0.01 (settings can be changed)					
Average hardness value		Average value of valid data					
Hardness variation		Variations in valid data (Max. - Min.)					
Scale		HRC/HR15N/HBW2.5/187.5 etc.					
Display		Hardness value, test condition, OK/NG judgment result, statistical calculation result, \bar{X} -R control chart, hardness conversion value					
Test numbering		When testing a single specimen: 1, 2, 3... When testing a group of specimens: 1/5-1, 2/5-1, 3/5-1, 4/5-1, 5/5-1, 1/5-2, 2/5-2...					
Hold time	Initial test force	1 to 120 s (configurable in seconds)					
	Total test force	1 to 120 s (configurable in seconds)					
Reading time		0 to 120 s (configurable in seconds)					
Hardness conversion		MITUTOYO HARD STEEL, SOFT METAL/SAE J417 T1/ASTM E140 T1, T2, T4 ISO 18265 TA. 1/BS 860 T2, T3, T4					
Judgment		OK, ±NG					
Correction		Displays whether or not correction was applied: cylindrical, spherical, user (multipoint/shift correction)					
Unit		mm (X-, Y- and Z-axis stage displacements)					
Power supply		AC100 to 240 V 50/60 Hz					
Mass		176 kg		181 kg		205 kg	

*1 Supplied as standard.

Note 1: Plastic tests may not be supported depending on the plastic material.

Note 2: For Brinell hardness testing, an indenter (optional) and a measurement microscope are required. A measurement microscope should be prepared by customer.

Note 3: No indenter and hardness standard block is supplied with the unit. These items (conform to the applicable standard) must be purchased separately.

Standard accessories

Order No.	Item	Specification / Remarks
11PAA366	Accessory box	
11AAD665	Booster	ø120 mm
11BAC135	Cable clamp CKN-13	
538615	Allen wrench	Size 2.5 mm
—	Communication cable (for USB)	

Order No.	Item	Specification / Remarks
12BAL402	Protective sheet	For main unit
—	User's manual	
—	Warranty card	In both Japanese and English
—	Tool kit	

☑ Rockwell hardness testing machines **HR-530 Series**

Unique electronic control makes the **HR-530 Series** of hardness testers extremely versatile by enabling Brinell (light force) hardness testing as well as load-sequence hardness testing of plastics, plus Rockwell and Rockwell Superficial hardness testing.



HR-530

- Maximum specimen dimension/
Height: 250 mm, Depth: 150 mm



HR-530L

- Maximum specimen dimension/
Height: 395 mm, Depth: 150 mm



Inside ring hardness testing



Hardness testing of internal surfaces, which previously was impossible without sectioning, is now possible. (All models.)
 The minimum diameter that can be tested is 34 mm as standard.
 Measurement can be performed down to an inside diameter of 22 mm by using the diamond indenter (19BAA292-optional).

Graphic display of \bar{X} -R control chart and statistical calculation results

Statistical calculation values such as the maximum, minimum, and mean, \bar{X} -R control charts, and histograms, which are required for hardness evaluation, can be displayed.

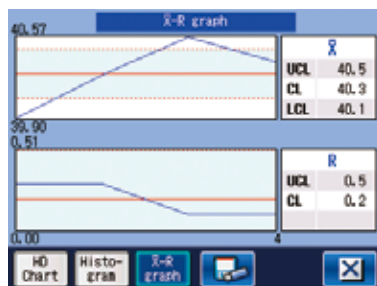

Equipped with the continuous measurement function

When multiple workpieces with the same height are to be tested, no adjustment of the platen height control wheel is required for the second or later workpieces. Continuous, speedy testing is possible just by pressing the foot switch or the START button on the main unit.

Display unit with a function-rich color touch-screen



5.7-inch color LCD

This unit adopts the user interface common to the **HM** and **HV Series**, adapted to include Rockwell hardness testing capabilities. It is equipped with a versatile color touch-screen for displaying the results of statistical calculations and graphics functions, etc.



The touch-screen display unit can be mounted on top of the tester, providing significant convenience if the machine installation space is restricted. (All models.)
 Use the optional display mounting bracket to mount the unit in this position.

Various shapes of specimen can be measured. (Nose-type indenter has been adopted)

The nose-type indenter allows internal measurement of pipe samples as well as the top surface of a flat sample.

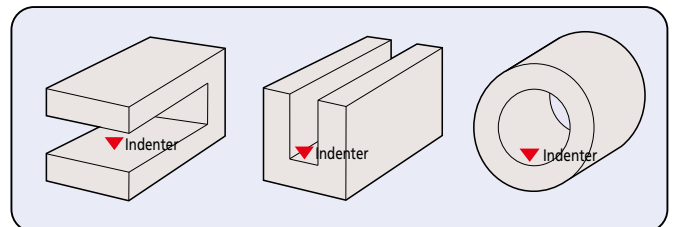

Interface ports on the rear panel



Touch-panel display

The HR-530/530L models offer the combination of rich functionality and excellent operability through the adoption of a display-mode-changeable touch screen.



HR-530

- Standard operating display

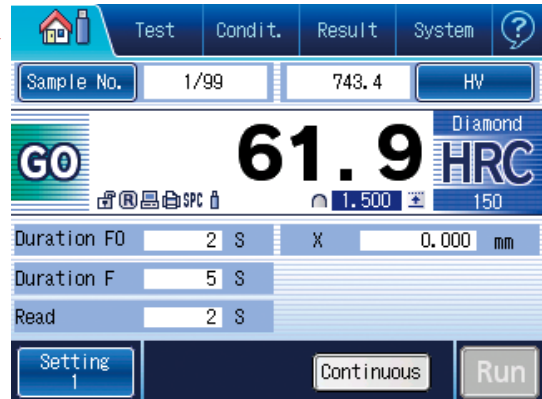

The display unit features USB2.0 Type A socket. Test results, statistical calculation results and test conditions can be saved as text data, and graphs can be saved as image data to a USB memory device.

- Direct hardness scale selection

The hardness scale, determined according to the test force and indenter combination, can be directly selected on the touch screen. Preliminary test force and test force are set automatically to match the chosen scale, offering great convenience.



- Curved surface compensation and measurement

The curve compensation function supporting specimens with curved surfaces such as round bars and spheres allows hardness testing of specimens of a wide range of shapes, not only flat specimens.

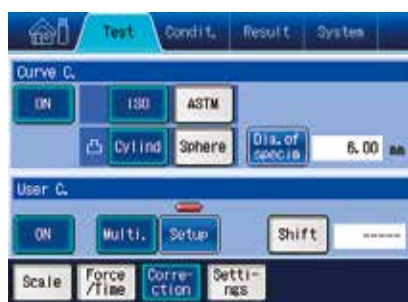

- Statistical analysis

Quality control processes involving hardness testing of industrial materials employ judgments based on test results for multiple points. This function performing calculation of statistics such as maximum, minimum and mean values and standard deviations is useful for analysis of multi-point test results.

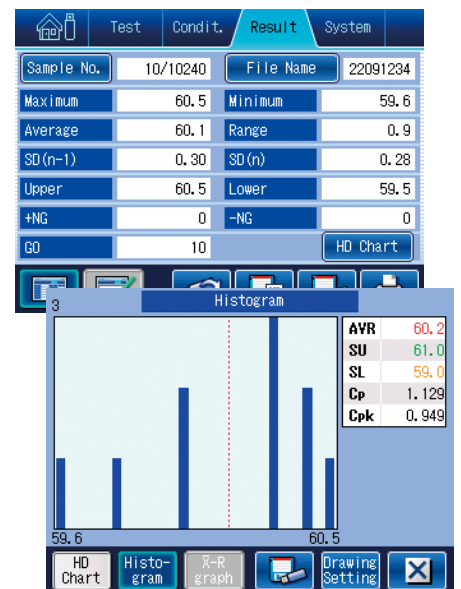

Specifications

Model		HR-530			HR-530L				
Display unit		metric		inch/mm		metric		inch/mm	
Applicable standards		JIS B7726/ISO 6508-2, ASTM E18-20							
Testable hardness		Rockwell hardness/Rockwell Superficial hardness/Brinell hardness/Indentation Brinell hardness/Plastics hardness							
Initial test force N (kgf)		29.42 (3)		98.07 (10)					
Test force N (kgf)	Rockwell	588.4 (60)		980.7 (100)		1471 (150)			
	Rockwell Superficial	147.1 (15)		294.2 (30)		441.3 (45)			
	Brinell	61.29 (6.25) 306.5 (31.25)		98.07 (10) 612.9 (62.5)		153.2 (15.625) 980.7 (100)		245.2 (25) 1226 (125) 294.2 (30) 1839 (187.5)	
Test force control		Auto (load, duration, unload)							
Table up/down mechanism		Manual (automatic brake for the preliminary test force)							
Operation unit		Color Touch-panel							
Test force switching		Via display unit							
Test force duration time		1 to 120 s (Can be set to any value in units of 1 s.)							
Maximum specimen dimensions		Height: 250 mm Depth: 150 mm			Height: 395 mm Depth: 150 mm				
Allowable inner diameter of pipe specimen		Minimum hole diameter: 35 mm (When the special specification indenter is used: 22 mm)							
Max. loading capacity		20 kg							
Display		Hardness value, Test condition, OK/NG judgment result, Statistical calculation result, X-R control chart, Hardness conversion value Conversion function [HV, HK, HR (Rockwell hardness A, B, C, D, F, G/Rockwell Superficial 15T, 30T, 45T, 15N, 30N, 45N), HS, HB, Tensile strength] Minimum hardness value: 0.1, Hardness value indicator: max. 6 digits (including decimal point and minus sign) OK/NG judgment function, Continuous measurement function (for specimens of the same thickness) Cylindrical correction, Spherical correction, Offset correction, Multi-point correction functions Statistical calculation function (Maximum value, minimum value, mean value, standard deviation, upper and lower limit values, OK count, range, NG count) Graph generation function (X-R control charts)							
Languages		15 languages are supported: Japanese, English, German, French, Italian, Spanish, Korean, Chinese (simplified/traditional), Turkish, Portuguese, Hungarian, Polish, Dutch and Czech							
External connection interface		RS-232C, Digimatic, USB Type A (for external USB memory), USB Type B (for PC communication)							
Power supply		AC100 to 240 V 50/60 kHz							
External dimensions	Body	250 (W) × 667 (D) × 621 (H) mm			300 (W) × 667 (D) × 766 (H) mm				
	Touch-panel display unit				191 (W) × 147 (D) × 71 (H) mm				
Mass		61 kg			70 kg				

Note 1: Plastic tests may not be supported depending on the plastic material.

Note 2: For Brinell hardness testing, an indenter (optional) and a measurement microscope are required. A measurement microscope should be prepared by customer.

Note 3: No indenter and hardness standard block is supplied with the unit. These items (conform to the applicable standard) must be purchased separately.

Standard accessories

Order No.	Item	Specification / Remarks	Order No.	Item	Specification / Remarks
810-039	Flat anvil	ø64 mm	—	Display unit	
810-040	V-anvil	ø40 mm Groove width: 30 mm	—	Level	
11AAD185	Display unit installation board		—	Tool kit	
383876	Vinyl cover	For HR-530	—	User's manual	
383228	Vinyl cover	For HR-530L	—	Inspection certificate	In both Japanese and English for the tester
12BAL402	Protective sheet	For main unit	—	Warranty card	In both Japanese and English
			—	Accessory box	

Additional information

The relation between the test force and indenter for Brinell hardness test is as follows.
For the Brinell hardness test, the following indenter (optional accessory) is required.

Test force (N)	Brinell hardness testing									
	61.29	98.07	153.2	245.2	294.2	306.5	612.9	980.7	1226	1839
11AAD469 ø1 Indenter for Brinell test		HBW1/10			HBW1/30					
11AAD470 ø2.5 Indenter for Brinell test	HBW2.5/6.25		HBW2.5/15.625			HBW2.5/31.25	HBW2.5/62.5			HBW2.5/187.5
11AAD471 ø5 Indenter for Brinell test				HBW5/25			HBW5/62.5		HBW5/125	
11AAD472 ø10 Indenter for Brinell test								HBW10/100		

Rockwell hardness testing machines HR-200/300/400 Series

The line-up features four types of machines with both digital and analogue display types.

Analog Rockwell hardness testing machine HR-210MR



HR-210MR Rockwell hardness testing machine

Manual weight changing (with total test force selected) and handling of preliminary test force. Motor drive controls loading sequence.

Digital Rockwell hardness testing machines HR-320MS/430MR/430MS



HR-320MS Dual type (Rockwell/ Rockwell superficial) hardness testing machine

Manually handles test force and preliminary test force selection. Motor drive controls loading sequence.



HR-430MR Rockwell hardness testing machine

Smart type, but supports dial switching power steering and support of all test standards and equipped with automatic brake handle auto start feature. Motor drive controls loading sequence.



HR-430MS Dual type (Rockwell/ Rockwell superficial combined use) hardness testing machine

Smart type, but supports dial switching power steering and support of all test standards and equipped with automatic brake handle auto start feature. Motor drive controls loading sequence.

Features

- The newly designed frame provides maximum clearance for positioning the workpiece. A flat table is all that is needed for mounting these testing machines.
- Analog type (**HR-210MR**) incorporates a dial indicator which needs no zero-setting, allowing easy setting of the preliminary test force.
- Digital types (**HR-430MR/430MS**), use an automatic steering wheel brake and automatic loading sequencing, making for easy operation.
- Digital types (**HR-320MS/430MR/430MS**) have Digimatic output and our Digimatic Mini-Processor (**DP-1VA LOGGER**) for hardcopy output, as well as input tools (**USB-ITN-E**) to connect to a PC for data transfer.



- Brinell hardness testing is also supported. An optional Brinell weight set, Brinell indenter, and measurement microscope are required. A measurement microscope should be prepared by customer.

Specifications

Model		HR-210MR	HR-320MS	HR-430MR	HR-430MS
Applicable standards		JIS B7726:2017, ISO 6508-2:2015	JIS B7726:2017, ISO 6508-2:2015, ASTM E18-20		
Testable hardness		Rockwell hardness			
Preliminary test force N (kgf)		98.07 (10)	Rockwell Superficial hardness 29.42 (3) 98.07 (10)	98.07 (10)	Rockwell Superficial hardness 29.42 (3) 98.07 (10)
Test force N (kgf)	Rockwell Superficial	—	147.1 (15) 294.2 (30) 441.3 (45)	—	147.1 (15) 294.2 (30) 441.3 (45)
	Rockwell	588.4 (60) 980.7 (100) 1471 (150)			
Hardness display		Analog		Digital	
Resolution		0.5 HR graduation		0.1 HR indication	
Preliminary test force (handling support)		Automatic pre-setting dial gauge		Loading navigator indication	
Preliminary test force switching		—		Dial switching	
Total test force switching		Weight change		Dial switching	
Total test force load operation		Motor drive, Button start		Motor drive, Automatic start	
Test force duration		Fixed 3-5.5 s or manual		3-60 s setting or manual operation	
Maximum specimen dimension		180 mm (100 mm if cover is attached) 165 mm (from indenter axis to the frame)			
Function		—			
		OK/NG judgment function			
		Offset correction function			
Data output interface		—			
Power supply		Digimatic RS-232C			
External dimensions		AC100 to 240 V 50/60 Hz 1.8 A DC12 V-4.17 A			
Mass		46 kg	47 kg	50 kg	

Note 1: Plastic tests may not be supported depending on the plastic material.

Note 2: Brinell hardness tests can be performed by using the weight set for Brinell test, Brinell indenter and measuring microscope. A measurement microscope should be prepared by customer.

Note 3: No indenter and hardness standard block is supplied with the unit. These items (conform to the applicable standard) must be purchased separately.

Standard accessories

Order No.	Item	Specification / Remarks	Order No.	Item	Specification / Remarks
810-039	Flat anvil	Outside diameter ϕ 64 mm		User's manual	
810-040	V-anvil (large)	ϕ 40 mm, Groove Angle 120°, V-groove 30 mm wide		Vinyl cover	
357651	AC adapter	IN: AC100 to 240 V 1.2 A OUT: DC12 V 3.5 A		Accessory box	
				Level	

Optional accessories: A weight set for Brinell test, an indenter, and a spare ball

Hardness testing machine	Weight set Item	Indenters for Brinell test			
		11AAD469 ϕ 1 mm	11AAD470 ϕ 2.5 mm	11AAD471 ϕ 5 mm	11AAD472 ϕ 10 mm
HR-210MR	Brinell weight set 62.5 125 187.5	—	HBW2.5/62.5 HBW2.5/187.5	HBW5/62.5 HBW5/125	(HBW10/100*)
HR-320MS	Brinell weight set 31.25 62.5 125 187.5	(HBW1/30*)	HBW2.5/31.25 HBW2.5/62.5 HBW2.5/187.5	HBW5/62.5 HBW5/125	(HBW10/100*)
HR-430MR	Brinell weight set 62.5 125 187.5	—	HBW2.5/62.5 HBW2.5/187.5	HBW5/62.5 HBW5/125	(HBW10/100*)
HR-430MS	Brinell weight set 31.25 62.5 125 187.5	(HBW1/30*)	HBW2.5/31.25 HBW2.5/62.5 HBW2.5/187.5	HBW5/62.5 HBW5/125	(HBW10/100*)

Spare carbide ball				
Order No.	19BAA281	19BAA283	19BAA162	19BAA163
Item	1 mm	2.5 mm	5 mm	10 mm
Size (Quantity)	ϕ 1 mm (1 pc.)	ϕ 2.5 mm (1 pc.)	ϕ 5 mm (1 pc.)	ϕ 10 mm (1 pc.)

* The built-in weights are used for this range. Only an indenter needs to be selected.
Please use a microscope that can measure length.

Optional accessories for Rockwell hardness testing machines







Item	Order No.	Description	HR-210MR	HR-320MS	HR-430MR	HR-430MS	HR-530	HR-530L	HR-610A	HR-620A	HR-620B (for display unit)	HR-620B (for PC)
Display unit	11AAD599	mm 										●
	11AEE450	mm/inch										●
FORMEio	12AAU423											●
Diamond indenter	19BAA292	(Stem high 5 mm type)					●	●				
	19BAA072	(R models)	●	●								
	19BAA073	(R/S models)		●	●	●	●	●	●	●	●	●
Rockwell diamond indenter ASTM	11AAE318			●	●	●	●	●	●	●	●	●
Steel ball indenter	11AAD461	ø1.5875 mm (1/16 in)	●	●	●	●	●	●	●	●	●	●
	11AAD462	ø3.175 mm (1/8 in)	●	●	●	●	●	●	●	●	●	●
	11AAD463	ø6.35 mm (1/4 in)	●	●	●	●	●	●	●	●	●	●
	11AAD464	ø12.7 mm (1/2 in)	●	●	●	●	●	●	●	●	●	●
	11AAD733	ø6.35 mm (1/4 in) Stem 16 mm							●	●	●	●
	11AAD734	ø12.7 mm (1/2 in) Stem 16 mm							●	●	●	●
Spare steel ball	19BAA082	ø1.5875 mm (1/16 in)	●	●	●	●	●	●	●	●	●	●
	19BAA083	ø3.175 mm (1/8 in)	●	●	●	●	●	●	●	●	●	●
	19BAA084	ø6.35 mm (1/4 in)	●	●	●	●	●	●	●	●	●	●
	19BAA085	ø12.7 mm (1/2 in)	●	●	●	●	●	●	●	●	●	●
Carbide ball indenter	11AAD465	ø1.5875 mm (1/16 in)	●	●	●	●	●	●	●	●	●	●
	11AAD466	ø3.175 mm (1/8 in)	●	●	●	●	●	●	●	●	●	●
	11AAD467	ø6.35 mm (1/4 in)	●	●	●	●	●	●	●	●	●	●
	11AAD468	ø12.7 mm (1/2 in)	●	●	●	●	●	●	●	●	●	●
	11AAD735	ø6.35 mm (1/4 in) Stem 16 mm							●	●	●	●
	11AAD742	ø12.7 mm (1/2 in) Stem 16 mm							●	●	●	●
Carbide ball indenter ASTM	11AAE319	ø1.5875 mm (1/16 in)		●	●	●	●	●	●	●	●	●
	11AAE320	ø3.175 mm (1/8 in)		●	●	●	●	●	●	●	●	●
	11AAE321	ø6.35 mm (1/4 in)		●	●	●	●	●	●	●	●	●
	11AAE322	ø12.7 mm (1/2 in)		●	●	●	●	●	●	●	●	●
Spare carbide ball	19BAA507	ø1.5875 mm (1/16 in)	●	●	●	●	●	●	●	●	●	●
	19BAA508	ø3.175 mm (1/8 in)	●	●	●	●	●	●	●	●	●	●
	19BAA509	ø6.35 mm (1/4 in)	●	●	●	●	●	●	●	●	●	●
	19BAA510	ø12.7 mm (1/2 in)	●	●	●	●	●	●	●	●	●	●
Spare carbide ball ASTM	11AAE323	ø1.5875 mm (1/16 in)		●	●	●	●	●	●	●	●	●
	11AAE324	ø3.175 mm (1/8 in)		●	●	●	●	●	●	●	●	●
	11AAE325	ø6.35 mm (1/4 in)		●	●	●	●	●	●	●	●	●
	11AAE326	ø12.7 mm (1/2 in)		●	●	●	●	●	●	●	●	●

Item	Order No.	Description																		
			HR-210MR	HR-320MS	HR-430MR	HR-430MS	HR-530	HR-530L	HR-610A	HR-620A	HR-620B (for display unit)	HR-620B (for PC)								
Brinell weight set	—	62.5/125/187.5 kgf	●																	
	—	31.25/62.5/125/187.5 kgf		●																
	—	62.5/125/187.5 kgf			●															
	—	31.25/62.5/125/187.5 kgf				●														
Carbide ball indenter for Brinell hardness test	11AAD469	ø1 mm		●		●	●	●												
	11AAD470	ø2.5 mm	●	●	●	●	●	●												
	11AAD471	ø5 mm	●	●	●	●	●	●												
	11AAD472	ø10 mm	●	●	●	●	●	●												
Indenter for Brinell hardness test	11AAD721	ø1 mm Stem 16 mm								●	●	●	●							
	11AAD722	ø2.5 mm Stem 16 mm								●	●	●	●							
	11AAD723	ø5 mm Stem 16 mm								●	●	●	●							Contactor (large) 11AAD385 is required.
	11AAD724	ø10 mm Stem 16 mm								●	●	●	●							Contactor (large) 11AAD385 is required.
Spare carbide ball for Brinell hardness test	19BAA281	ø1 mm		●		●	●	●	●	●	●	●	●	●	●	●	●	●	●	●
	19BAA283	ø2.5 mm	●	●	●	●	●	●	●	●	●	●	●	●	●	●	●	●	●	●
	19BAA162	ø5 mm	●	●	●	●	●	●	●	●	●	●	●	●	●	●	●	●	●	●
	19BAA163	ø10 mm	●	●	●	●	●	●	●	●	●	●	●	●	●	●	●	●	●	●
Indentation Vickers hardness (HVT) indenter	11AAE254												●	●	●					
Hardness standard block	19BAA035	10HRC	●	●	●	●	●	●	●	●	●	●	●	●	●	●	●	●	●	●
	19BAA036	20HRC	●	●	●	●	●	●	●	●	●	●	●	●	●	●	●	●	●	●
	19BAA037	30HRC	●	●	●	●	●	●	●	●	●	●	●	●	●	●	●	●	●	●
	19BAA038	40HRC	●	●	●	●	●	●	●	●	●	●	●	●	●	●	●	●	●	●
	19BAA039	50HRC	●	●	●	●	●	●	●	●	●	●	●	●	●	●	●	●	●	●
	19BAA040	60HRC	●	●	●	●	●	●	●	●	●	●	●	●	●	●	●	●	●	●
	19BAA041	70HRC	●	●	●	●	●	●	●	●	●	●	●	●	●	●	●	●	●	●
	19BAA042	41HR 30N		●		●	●	●	●	●	●	●	●	●	●	●	●	●	●	●
	19BAA043	50HR 30N		●		●	●	●	●	●	●	●	●	●	●	●	●	●	●	●
	19BAA044	60HR 30N		●		●	●	●	●	●	●	●	●	●	●	●	●	●	●	●
	19BAA045	73HR 30N		●		●	●	●	●	●	●	●	●	●	●	●	●	●	●	●
	19BAA046	83HR 30N		●		●	●	●	●	●	●	●	●	●	●	●	●	●	●	●
	19BAA047	75HR 15N		●		●	●	●	●	●	●	●	●	●	●	●	●	●	●	●
	19BAA048	85HR 15N		●		●	●	●	●	●	●	●	●	●	●	●	●	●	●	●
	19BAA049	90HR 15N		●		●	●	●	●	●	●	●	●	●	●	●	●	●	●	●
	19BAA028	32HRBS	●	●	●	●	●	●	●	●	●	●	●	●	●	●	●	●	●	●
	19BAA029	42HRBS	●	●	●	●	●	●	●	●	●	●	●	●	●	●	●	●	●	●
	19BAA030	52HRBS	●	●	●	●	●	●	●	●	●	●	●	●	●	●	●	●	●	●
	19BAA031	62HRBS	●	●	●	●	●	●	●	●	●	●	●	●	●	●	●	●	●	●
	19BAA032	72HRBS	●	●	●	●	●	●	●	●	●	●	●	●	●	●	●	●	●	●
	19BAA033	82HRBS	●	●	●	●	●	●	●	●	●	●	●	●	●	●	●	●	●	●
	19BAA034	90HRBS	●	●	●	●	●	●	●	●	●	●	●	●	●	●	●	●	●	●
	11AAD474	32HRBW	●	●	●	●	●	●	●	●	●	●	●	●	●	●	●	●	●	●
	11AAD475	42HRBW	●	●	●	●	●	●	●	●	●	●	●	●	●	●	●	●	●	●
11AAD476	52HRBW	●	●	●	●	●	●	●	●	●	●	●	●	●	●	●	●	●	●	
11AAD477	62HRBW	●	●	●	●	●	●	●	●	●	●	●	●	●	●	●	●	●	●	
11AAD478	72HRBW	●	●	●	●	●	●	●	●	●	●	●	●	●	●	●	●	●	●	
11AAD479	82HRBW	●	●	●	●	●	●	●	●	●	●	●	●	●	●	●	●	●	●	
11AAD480	90HRBW	●	●	●	●	●	●	●	●	●	●	●	●	●	●	●	●	●	●	
11AAD194	90HRES	●	●	●	●	●	●	●	●	●	●	●	●	●	●	●	●	●	●	
11AAD195	90HREW	●	●	●	●	●	●	●	●	●	●	●	●	●	●	●	●	●	●	





Item	Order No.	Description										
			HR-210MR	HR-320MS	HR-430MR	HR-430MS	HR-530	HR-530L	HR-610A	HR-620A		HR-620B (for display unit) HR-620B (for PC)
	19BAA050	32HR 30TS	●	●	●	●	●	●	●	●	●	Compliant with JIS standards With an inspection certificate from the standard block manufacturer.
	19BAA051	42HR 30TS	●	●	●	●	●	●	●	●	●	
	19BAA052	52HR 30TS	●	●	●	●	●	●	●	●	●	
	19BAA053	62HR 30TS	●	●	●	●	●	●	●	●	●	
	19BAA054	72HR 30TS	●	●	●	●	●	●	●	●	●	
	19BAA055	78HR 15TS	●	●	●	●	●	●	●	●	●	
	19BAA056	80HR 15TS	●	●	●	●	●	●	●	●	●	
	19BAA057	87HR 15TS	●	●	●	●	●	●	●	●	●	
	11AAD481	32HR 30TW	●	●	●	●	●	●	●	●	●	Compliant with ISO/JIS standards With an inspection certificate from the standard block manufacturer.
	11AAD482	42HR 30TW	●	●	●	●	●	●	●	●	●	
	11AAD483	52HR 30TW	●	●	●	●	●	●	●	●	●	
	11AAD484	62HR 30TW	●	●	●	●	●	●	●	●	●	
	11AAD485	72HR 30TW	●	●	●	●	●	●	●	●	●	
	11AAD486	78HR 15TW	●	●	●	●	●	●	●	●	●	
	11AAD487	80HR 15TW	●	●	●	●	●	●	●	●	●	
	11AAD488	87HR 15TW	●	●	●	●	●	●	●	●	●	
	11AAE327	30HRC ASTM	●	●	●	●	●	●	●	●	●	Compliant with ASTM/ISO standards With class B calibration certificate and inspection certificate
	11AAE328	45HRC ASTM	●	●	●	●	●	●	●	●	●	
	11AAE329	63HRC ASTM	●	●	●	●	●	●	●	●	●	
	11AAE330	30HRBW ASTM	●	●	●	●	●	●	●	●	●	
	11AAE331	70HRBW ASTM	●	●	●	●	●	●	●	●	●	
	11AAE332	90HRBW ASTM	●	●	●	●	●	●	●	●	●	
	11AAE333	65HRA ASTM	●	●	●	●	●	●	●	●	●	
	11AAE334	76HRA ASTM	●	●	●	●	●	●	●	●	●	
	11AAE335	85HRA ASTM	●	●	●	●	●	●	●	●	●	
	11AAE336	75HR15N ASTM	●	●	●	●	●	●	●	●	●	
	11AAE337	85HR15N ASTM	●	●	●	●	●	●	●	●	●	
	11AAE338	92HR15N ASTM	●	●	●	●	●	●	●	●	●	
	11AAE339	50HR30N ASTM	●	●	●	●	●	●	●	●	●	
	11AAE340	68HR30N ASTM	●	●	●	●	●	●	●	●	●	
	11AAE341	83HR30N ASTM	●	●	●	●	●	●	●	●	●	
	11AAE342	25HR45N ASTM	●	●	●	●	●	●	●	●	●	
	11AAE343	43HR45N ASTM	●	●	●	●	●	●	●	●	●	
	11AAE344	72HR45N ASTM	●	●	●	●	●	●	●	●	●	
	11AAE345	67HR15TW ASTM	●	●	●	●	●	●	●	●	●	
	11AAE346	83HR15TW ASTM	●	●	●	●	●	●	●	●	●	
	11AAE347	91HR15TW ASTM	●	●	●	●	●	●	●	●	●	
	11AAE348	36HR30TW ASTM	●	●	●	●	●	●	●	●	●	
	11AAE349	63HR30TW ASTM	●	●	●	●	●	●	●	●	●	
	11AAE350	76HR30TW ASTM	●	●	●	●	●	●	●	●	●	
	11AAE360	75HREW ASTM	●	●	●	●	●	●	●	●	●	
	11AAE361	87HREW ASTM	●	●	●	●	●	●	●	●	●	
	11AAE362	100HREW ASTM	●	●	●	●	●	●	●	●	●	

Hardness standard block





Common applications

Item	Order No.	Description	HR-210MR HR-320MS HR-430MR HR-430MS HR-530 HR-530L HR-610A HR-620A HR-620B (for display unit) HR-620B (for PC)															
External output	264-505	Digimatic Mini-Processor DP-1VA LOGGER 	●	●	●	●	●	●	●	●	●							Connection cable is required.
	936937	Connection cable (1 m) Type D										●	●	●	●	●		10-pin plain connector (Type D) for IT-020U
	937387	Connection cable (1 m) Type E	●	●	●													6-pin round connector (Type E) for IT-020U and DP-1VA
	12AAJ112	Connection cable (1 m) Type D (EMC test type)							●	●	●	●	●					For DP-1VA 10-pin plain connector (Type D)
	09EAA082	Printing paper	●	●	●	●	●	●	●	●	●	●	●					For DP-1VA (10 rolls)
	02AZD810D	U-WAVE-R 	●	●	●	●	●	●	●	●	●	●	●					Requires a separate PC for connection
	02AZD730G	U-WAVE-T (IP67 type) 	●	●	●	●	●	●	●	●	●	●	●					U-WAVE-T dedicated connection cable is required.
	02AZD880G	U-WAVE-T (buzzer type) 	●	●	●	●	●	●	●	●	●	●	●					U-WAVE-T dedicated connection cable is required.
	02AZD790E	U-WAVE-T dedicated connection cable	●	●	●													6-pin round connector (Type E)
	02AZD790D								●	●	●	●	●					
	264-020	Input tool IT-020U	●	●	●	●	●	●	●	●	●	●	●					Connection cable is required.
	06AFM380E	Input tool direct USB-ITN-E 	●	●	●													6-pin round connector
	06AFM380D	Input tool direct USB-ITN-D 							●	●	●	●	●					10-pin plain connector
	11AAC236	Data processing software for Hardness testing machines EXPAK-06							●	●	●	●	●					PC and Office are not included.
	02NDB101D	MeasurLink® Real-Time Professional															●	Supports only PC specifications (AVPAK specifications)
02NDB102D	MeasurLink® Real-Time Professional 3D															●	Supports only PC specifications (AVPAK specifications)	

Specimen fixtures

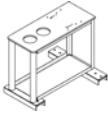
Item	Order No.	Description	HR-210MR	HR-320MS	HR-430MR	HR-430MS	HR-530	HR-530L	HR-610A	HR-620A	HR-620B (for display unit)	HR-620B (for PC)
VARI-REST	810-027		●	●	●	●	●					
Jack rest	810-028		●	●	●	●	●					
Special V-anvil (max. ø100 mm)	810-029		●	●	●	●	●					
Diamond-spot anvil	810-030			●		●	●					
Round table	810-037		●	●	●	●	●	●				
	810-038											
V-anvil	810-040		●	●	●	●	●	●				
	810-041		●	●	●	●	●	●				
	810-042	●	●	●	●	●	●					
	810-043 ø12 mm 810-044 ø5.5 mm	●	●	●	●	●	●					
	11AAD630								●	●	●	●
Contactor (large)	11AAD385								●	●	●	●
Fine adjustment table for Jominy test	810-700						●	●				
	810-701											
X-axis stage	810-530 160 mm 810-531 300 mm								●	●		
	810-535 160 mm 810-536 300 mm										●	●

Other optional accessories

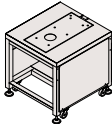
Item	Order No.	Description	HR-210MR	HR-320MS	HR-430MR	HR-430MS	HR-530	HR-530L	HR-610A	HR-620A	HR-620B (for display unit)	HR-620B (for PC)
Calibration certificate			●	●	●	●	●	●	●	●	●	●
Console tables	810-048		●	●	●	●						560 (W)×700 (D)×554 (H) mm
	11AAD186 (Reinforced base providing stability)						●	●				560 (W)×720 (D)×559 (H) mm
	11AAD668 For HR-610A/620A (A)								●	●		560 (W)×760 (D)×642 (H) mm
	11AAD671 For HR-620B (B)									●	●	820 (W)×910 (D)×642 (H) mm
Vibration isolator	810-643						●	●				720 (W)×770 (D)×700 (H) mm
System rack	998923										●	For PC

Software for Hardness testing machines AVPAK

Note 1: The AVPAK-20 software package is not for use within, or export to, the United States of America.
The AVPAK-10 software package is for the United States of America.
Note 2: For Stitching, Auto trace, and Contour detection are functions only for AVPAK-20.

Introduction of software AVPAK-10/20 function (HM-200 Series, HV-100 Series)

Graphic view (of stored images)

For displaying the entire specimen and checking the pattern positioning. The digital zoom function can be used to easily magnify and check the indentation site.

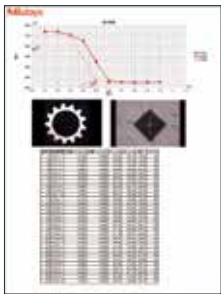
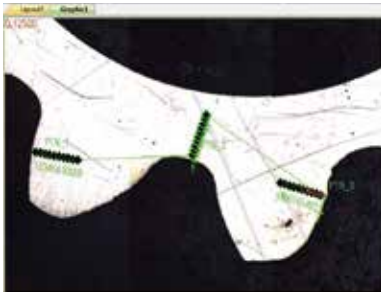

Layout view
Photos from individual views, graphs, tables, etc., can be laid out freely to help with report creation.

Part program

Automatically records the sequence of operations in a test. To repeat the same test, the part program can be called up for repeated execution.

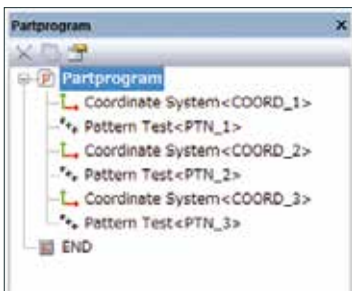

Parts manager

Test result list view

Hardness distribution diagram

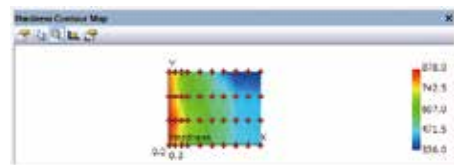

Test result view

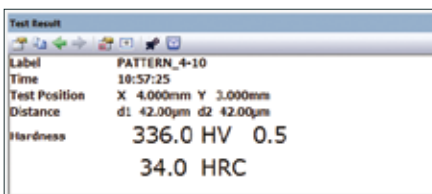

Hardness curve graph

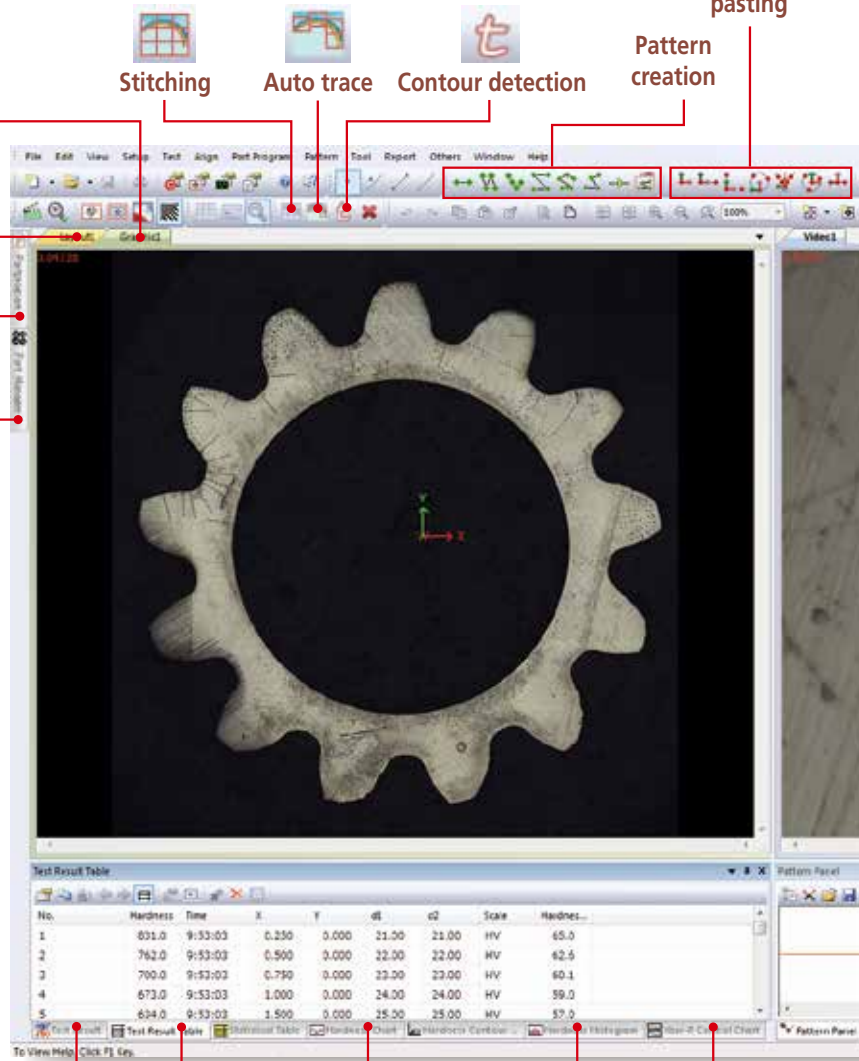

Note: All the screens shown in this page are for AVPAK-20.

**Video view (live image)
Indentation image display**
Small indentations can be observed using the digital zoom function.

Contrast level meter
Stable focusing can be easily achieved by anyone.

Counter
Displays the stage's current coordinates.
(Z-axis information is only for System D)

Property panel

Test control
Controls test actions such as wide- or narrow-range auto-focusing and measurement of indentations.

Turret control
Switches the objective lens and indenter in and out of the test position

Illumination control
Controls the illumination in 100 steps

Stage control
Used to move the motorized XY stage and AF stage.
(Systems C and D only)

Pattern panel

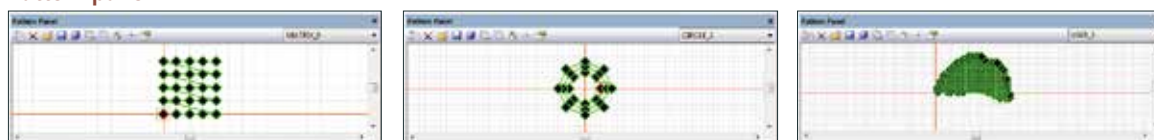

Frequency distribution graph

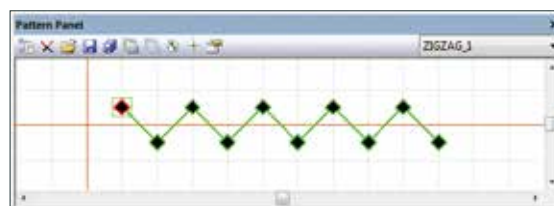

Note: All the screens shown in this page are for AVPAK-20.

Feature of software AVPAK-10/20 function

Function related to capture of specimen image and pattern setting of test position

Stitching (Only for AVPAK-20)
Takes images of an entire rectangular field from the moving stage then combines the images.

Note: Only for System C/D of HM/HV

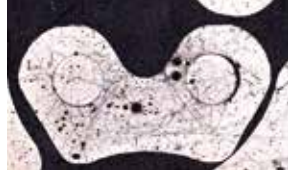

Auto trace (Only for AVPAK-20)
Automatically traces the shape of the sample. Takes images as the stage moves along the outer contours of the specimen then combines the images.

Note: Only for System C/D of HM/HV



Contour detection (Only for AVPAK-20)
Detects the outline of the workpiece from combined images.

Various kinds of pattern setting
Performs time-consuming pattern setting with ease.



Pattern creation
This tool supports the creation of test patterns such as straight lines, zigzag lines, and teaching patterns.



Pattern pasting
This tool supports the pasting of created test patterns. It adjusts the origin, direction, etc., to paste a pattern.

Remote Control Box

Assists operation using AVPAK-10/20. Besides control of the motorized XY stage, the Remote Control Box can be used for turret switching, XY stage speed control and single-point testing.



There are four speeds to choose from for stage control using the joystick—Step, Low, Middle, and High.

Dimensions: 177×174×107 mm (W×D×H)
Mass: 1 kg

Note: Supplied with System C/D of HM/HV and HR-620B only

Note: With regarding to the AVPAK-20, not for use and/or export to the United States of America.

Handling of multiple specimens

Part program and Parts Manager functions support testing of multiple and irregular specimens.

Multi-specimen testing
Executes different part programs for each irregular specimen



Parts Manager
Executes a common part program for specimens having the same shape



Reading of indentations

Improvement in image-processing performance has improved the indentation measurement function.

Note 1: measurement accuracy varies according to conditions.
Note 2: Only for HM/HV



Simple test panel



Operations from test condition setting to test start are navigated with the guidance function.



Property panel

Used for setting the test conditions such as the test force and duration time, as well as the indentation measurement condition.



Navigation function

When the test position is being moved during multi-point testing, this function guides the travel of the XY manual stage to the next position. (System B)

Note: Only for System B with manual XY stage.

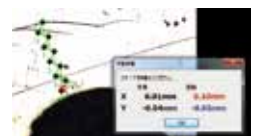

Introduction of software AVPAK-10/20 function (HR-600 Series)

(Refer to pages 38 to 40 for details of other functions)

The screenshot shows the AVPAK software interface with several key components highlighted:

- Test result table:** A table listing test parameters and results for 14 different test points.
- Test result view:** A central display showing a 3D coordinate system with a green test path overlaid on a dark background.
- Display test position on X-axis stage:** A panel on the right showing the current X, Y, and Z coordinates of the test position.
- Hardness curve graph:** A graph at the bottom left showing hardness values across different test points.
- Pattern panel:** A graph at the bottom center showing a zigzag pattern, likely representing the test path or frequency distribution.
- Control panel:** A panel on the right side containing buttons for 'Run', 'Stop', 'Record', and 'Time Left', along with a 'Target Panel' and a directional pad.

Test Result Table Data:

No.	Label	Time	X	Y	Hardness	Scale	OK/NG	Deviation
1	PTN_L1-1	19.2158	9.900	0.900	60.4	HRC	OK	
2	PTN_L1-2	15.4613	9.900	0.900	60.4	HRC	OK	
3	PTN_L1-3	15.4613	9.900	0.900	60.7	HRC	OK	
4	PTN_L1-4	12.4514	7.000	0.900	60.2	HRC	OK	
5	PTN_L1-5	19.4635	9.900	0.900	60.8	HRC	OK	
6	PTN_L1-6	19.9026	11.000	0.900	60.8	HRC	OK	
7	PTN_L1-7	19.9030	13.000	0.900	60.8	HRC	OK	
8	PTN_L1-8	19.9039	15.000	0.900	60.7	HRC	OK	
9	PTN_L1-9	15.5121	16.000	0.900	60.7	HRC	OK	
10	PTN_L1-10	12.2546	23.000	0.900	60.4	HRC	OK	
11	PTN_L1-11	19.6212	16.000	0.900	60.7	HRC	OK	
12	PTN_L1-12	19.5233	25.000	0.900	60.2	HRC	OK	
13	PTN_L1-13	19.4709	14.000	1.400	60.1	HRC	OK	
14								

Software for Touch-panel

Easy-to-understand graphic display enables intuitive operation. Functions for converting values and compensating for curved surfaces, as well as a test condition guiding function are all provided as standard features.

The user interface is of the same design across all testing machines, ensuring user-friendly operation.

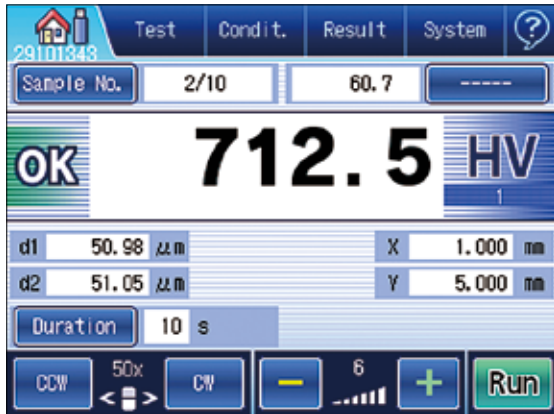

The standard screen displays test results and test conditions. Various types of information can be confirmed on this one screen.



This screen supports setting of test conditions such as verification of the minimum thickness of a workpiece at the specified test force.



The simple screen displays only test results. The extra-large characters help prevent reading errors.



This screen allows setting of a conversion scale, GO/NG judgment and external output. It allows instantaneous verification of settings in the form of a list.

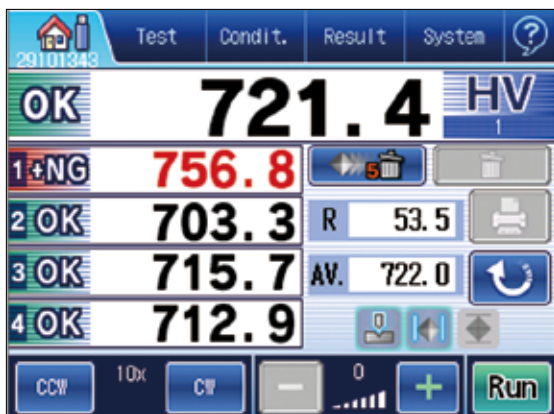

The list screen displays the last five test results, average, and variation. This screen is optimal for displaying the average of multiple test points.



This screen provides a list of statistics of test results. It allows easy storing and printing results simply by clicking the icon.

FORMEio for external communication program

AUTOMATION Enables smooth and efficient measurements

By installing an X-axis stage on an **HR-620B** machine and creating a system that coordinates with robots, you can automate the testing procedure, from mounting workpieces to sorting them according to test results.



Example of hardness testing machine automation on a production line

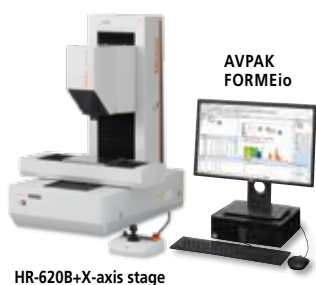

HR-620B+X-axis stage



HV-100

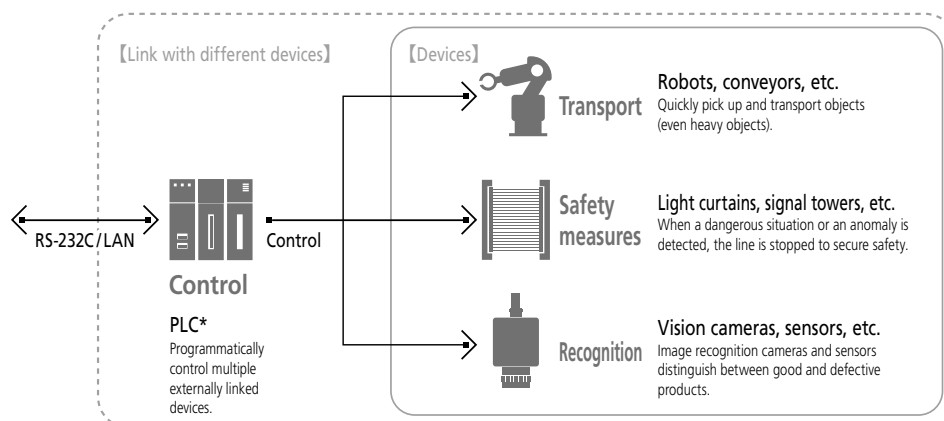

* Programmable Logic Controller

Rebound type portable hardness tester Hardmatic HH-411

HH-411 is a rebound type portable hardness tester for metal with a compact body and high operability. It allows anyone to perform hardness testing easily at the touch of a key, so it can be used widely on various components in the field.



HH-411

Rich variety of detectors available

In addition to the general-purpose detector (D type) supplied as standard equipment, the detector lineup includes rich variations (sold separately) to support special applications. The DC type is provided for hardness testing of internal walls of pipes with diameters that cannot be tested with the D type, the D+15 type for bearings and gears, and the DL type for small areas such as the bottom of small gears and weld corners.

Equipped with automatic orientation correction

For the rebound type hardness tester, gravity affects the measurement result depending on the orientation of the detector relative to the vertical when pressed against the specimen surface. The **HH-411** is equipped with the latest measurement technology that automatically detects the orientation of the detector to automatically correct for this effect. For this reason, the setting for orientation of the detector is not required.

Hardness testing of small surfaces is possible

Only a small surface (standard D type: $\varnothing 22$ mm, separately sold DL type: $\varnothing 4$ mm) area is required for hardness testing. Therefore the **HH-411** can be used for testing of various specimen shapes such as around grooves and gear teeth.

Equipped with a data save function

Up to 1800 hardness test results can be saved, which is useful for patrol tests in the field.

Hardness scale can be selected for your own individual purpose

Based on the Leeb hardness HL value (L value: according to ASTM A 956), conversion can be performed to Vickers, Brinell, Rockwell C, Rockwell B, and Shore hardness as well as tensile strength. Conversion can be performed after the test, or hardness value display in the conversion mode is also available. Leeb hardness is calculated with the HV-HL (Vickers to Leeb) conversion formula revised in 2016. It is also possible to switch to Leeb hardness calculated with the previous HV-HL conversion formula.

Great operability

The basic operation is to press the detector against the sample surface and push the detector button by your finger, just like clicking a ballpoint pen, so it is easy for anyone to do. The tester automatically recognises the detector, allowing you to smoothly start testing after replacement.

Application examples for each detector type



• DC Type: UD-412



• Hardness testing of internal walls of pipes and tight spaces



• D+15 Type: UD-413

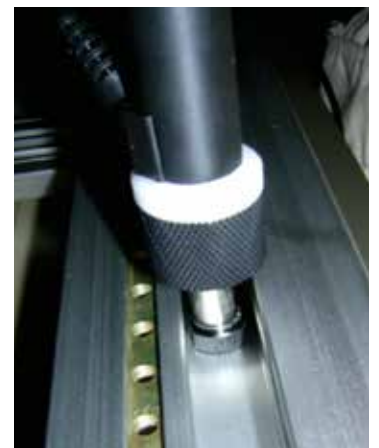

• Hardness testing in gaps and grooves and with slightly uneven surfaces



• DL Type: UD-414



• Small surfaces such as bottom lands of gears and weld corners

Long type

Compact type

Durometers for sponge, rubber, and plastic Hardmatic HH-300 Series

The **Hardmatic HH-300 Series** includes a slim and easy-to-handle long type and a compact type that fits easily in your hand. Both types have 2 types of display specifications, analog and digital.



Measuring hardness just requires pressing the hardness tester against the specimen and reading the indicated value.

Various kinds of sample can be tested for hardness, from soft sponge to hard plastic. Also, various measurement locations on the specimen can be used, such as a flat surface, a hole, or the bottom of a groove. The 10 models of hardness testers in the **HH-300 Series** support various hardness measurement standards.

Long type HH-331, 332, 333, 334, 335-01, 337-01

The long type has a slender cylindrical shape (ø24×85 mm). Due to this it can measure hardness at the bottom of grooves or holes as well as exposed surfaces. Also, hardness measurement can be performed while keeping your hands and face away from the specimen surface. This is essential when the surface temperature is high: for example immediately after molding.



Compact type HH-329, 330, 335, 336, 337, 338, 335-01, 336-01, 337-01, 338-01

The compact body fits snugly into your palm for ease of measurement.

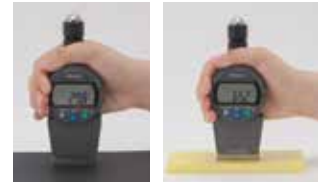

Specifications

Order No.	811-329-10	811-330-10	811-331-10	811-332-10	811-333-10	811-334-10
Model	HH-329	HH-330	HH-331	HH-332	HH-333	HH-334
Type	Compact type			Long type		
Display specification	Analog	Digital	Analog	Digital	Analog	Digital
Measurement target	Soft rubber, sponge, felt, hard foam, winder			General rubber/soft plastic		Hard rubber/hard plastic/ebonite
Category in standards	Type E			Type A		Type D
Needle shape	Shaft diameter	ø5 mm		ø1.25 mm		
	Tip shape	Semi-sphere		Circular truncated cone		Cone
	Tip angle	—		35°		30°
	Tip diameter	—		ø0.79 mm		—
	Tip curvature	—		—		0.1 mm
Pressure surface shape	44×18 mm			ø18 mm		
Protrusion of needle from pressure surface	2.5 mm			2.5 mm		
Minimum graduation	1' (HH-329, 331, 333, 335, 337) 0.1' (HH-330, 332, 334, 336, 338)					
Loading device	Coil spring method W _E =550+75 H _E		Coil spring method W _A =550+75 H _A (H _A : 10 to 90)		Coil spring method W _b =444.5 H _b (H _b : 20 to 90)	
H _E , H _A , H _b Hardness value	(H _E 10: W _E 1300 mN, H _E 90: W _E 7300 mN)		(H _A 10: W _A 1300 mN, H _A 90: W _A 7300 mN)		(H _b 20: W _b 8890 mN, H _b 90: W _b 40005 mN)	
Accuracy of spring force	±68.6 mN		±68.6 mN		±392.3 mN	
Functions	Peak hold	Hold function Output function: Digimatic interface for printer Tolerance judgment Function lock	Peak hold	Hold function Output function: Digimatic interface for printer Tolerance judgment Function lock	Peak hold	Hold function Output function: Digimatic interface for printer Tolerance judgment Function lock
External dimensions (W×D×H)	68×34×146 mm	59×40×147 mm	Analog long 68×35×188 mm Digital long 59×41×190 mm			
Mass	300 g	290 g	320 g	310 g	320 g	310 g
Power supply	—	Button silver oxide battery SR44	—	Button silver oxide battery SR44	—	Button silver oxide battery SR44

Hold function HH-330, 332, 334, 336, 338

Holds the display value at any time during measurement so that you can easily check the measurement result.



Peak hold function HH-329, 331, 333, 335, 337

The peak hold indicator attached to the analog display is very useful for peak value measurement.



Output zero set function HH-330, 332, 334, 336, 338

A Digimatic output interface is standard, so they can be connected to the DP-1VA LOGGER (special accessory) and measurement system. By using the ZERO switch, which also serves as the power switch, you can correct any small shift of the zero position due to a quantization error.

Specifications

Order No.	811-335-10	811-335-11	811-336-10	811-336-11	811-337-10	811-337-11	811-338-10	811-338-11	
Model	HH-335	HH-335-01	HH-336	HH-336-01	HH-337	HH-337-01	HH-338	HH-338-01	
Type	Compact type								
Display specification	Analog			Digital		Analog		Digital	
Measurement target	General rubber/soft plastic				Hard rubber/hard plastic/ebonite				
Category in standards	Type A				Type D				
Needle shape	Shaft diameter	ø1.25 mm							
	Tip shape	Circular truncated cone				Cone			
	Tip angle	35°				30°			
	Tip diameter	ø0.79 mm				—			
	Tip curvature	—				0.1 mm			
Pressure surface shape	44×18 mm	ø18 mm	44×18 mm	ø18 mm	44×18 mm	ø18 mm	44×18 mm	ø18 mm	
Protrusion of needle from pressure surface	2.5 mm								
Minimum graduation	1° (HH-331, 333, 335, 337) 0.1° (HH-332, 334, 336, 338)								
Loading device We, Wa, Wb, spring force (mN) Ha, Hb Hardness value	Coil spring method Wa=550+75 Ha (Ha: 10 to 90) (Ha 10: Wa 1300 mN, Ha 90: Wa 7300 mN)				Coil spring method Wb=444.5 Hb (Hb: 20 to 90) (Hb 20: Wb 8890 mN, Hb 90: Wb 40005 mN)				
	Accuracy of spring force	±68.6 mN				±392.3 mN			
Functions	Peak hold		Hold function Output function: Digimatic interface for printer Tolerance judgment Function lock		Peak hold		Hold function Output function: Digimatic interface for printer Tolerance judgment Function lock		
External dimensions (W×D×H)	Analog compact 68×34×146 mm Digital compact 59×40×147 mm								
Mass	300 g		290 g		300 g		290 g		
Power supply	—		Button silver oxide battery SR44		—		Button silver oxide battery SR44		

Optional accessories

Measurement/test dual purpose stand CTS Series (all models)

The **CTS Series** can be combined with the **HH-300 Series** for (1) hardness measurement, and (2) spring force testing of the **HH-300 Series** hardness tester main unit. (3) By connecting the attached weight directly to the hardness tester to perform hardness measurement results in better repeatability than can be obtained compared to hardness measurement made by directly pressing the hardness tester against the workpiece by hand. This measurement method with a weight directly connected to the hardness tester is useful for measuring the hardness of large samples for which the stand cannot be used, as well as hardness measurement in the field. The **CTS Series** includes 3 models for different hardness tester types. All 3 models can be used for (1), (2), and (3) above with one stand by adding a separately available accessory.



(1) Hardness measurement



(2) Spring force testing



(3) Direct application of weight

Specifications

Order No.	811-019	811-012	811-013
Model	CTS-101	CTS-102	CTS-103
Applicable model	HH-331 / 332	HH-333 / 334 / 337 / 338 / 337-01 / 338-01	HH-335 / 336 / 335-01 / 336-01
Application	1. Fixed force hardness measurement Measurement force	49.05 N	9.81 N
	Weight used	(1) + (3) + (4)	(1)
	2. Manual fixed force hardness measurement Measurement force	49.05 N	9.81 N
	Weight used	(1) + (3) + (6)	(1) + (6)
	3. Loading test Weight used	L: —/H: (1)	L: —/H: (1) + (2)
Weights	(1) CTS-101, 102, 103 Measurement/testing (2) CTS-103 Measurement (3) CTS-102 Measurement/testing (4) CTS-102 Measurement (5) CTS-102 Measurement/testing (6) CTS-101, 102, 103 Measurement		
	Weight application	(1) $\phi 64 \times 23.5$ (2) $\phi 40 \times 13$	(1) $\phi 64 \times 23.5$ (2) $\phi 20 \times 19$ (6) $\phi 40 \times 13$
	Outside diameter (Unit: mm)	(1) $\phi 64 \times 23.5$ (6) $\phi 40 \times 13$	(1) $\phi 64 \times 23.5$ (2) $\phi 20 \times 19$ (6) $\phi 40 \times 13$
	Body mass	(1) 580 g (2) 34.8 g (3) 3950 g (4) 50 g (5) 197.4 g (6) 130 g	
Stand (overview)	External dimensions	$\phi 148 \times$ Height (max.) 420 mm	
	Up/down stroke	12 mm	
	Maximum specimen thickness	Approx. 90 mm	
	Specimen table dimension	$\phi 90$ mm	
	Total mass	Approx. 9 kg	Approx. 9 kg

Standard configuration

Item	Usage	Quantity	811-019	811-012	811-013
			CTS-101	CTS-102	CTS-103
Main unit	—	1	✓	✓	✓
Tool set	—	1	✓	✓	✓
Weight (1)	Measurement/testing	1	✓	✓	✓
Weight (2)	Testing	1	—	—	✓
Weight (3)	Measurement/testing	1	—	✓	—
Weight (4)	Measurement/testing	1	—	✓	—
Weight (5)	Testing	1	—	✓	—
Weight (6)	Testing	2	✓	✓	✓
User's manual	—	1	✓	✓	✓
Warranty card	—	1	✓	✓	✓

System configuration

The **HH-300 Series** can be used more effectively by combining them with various special accessories (sold separately).

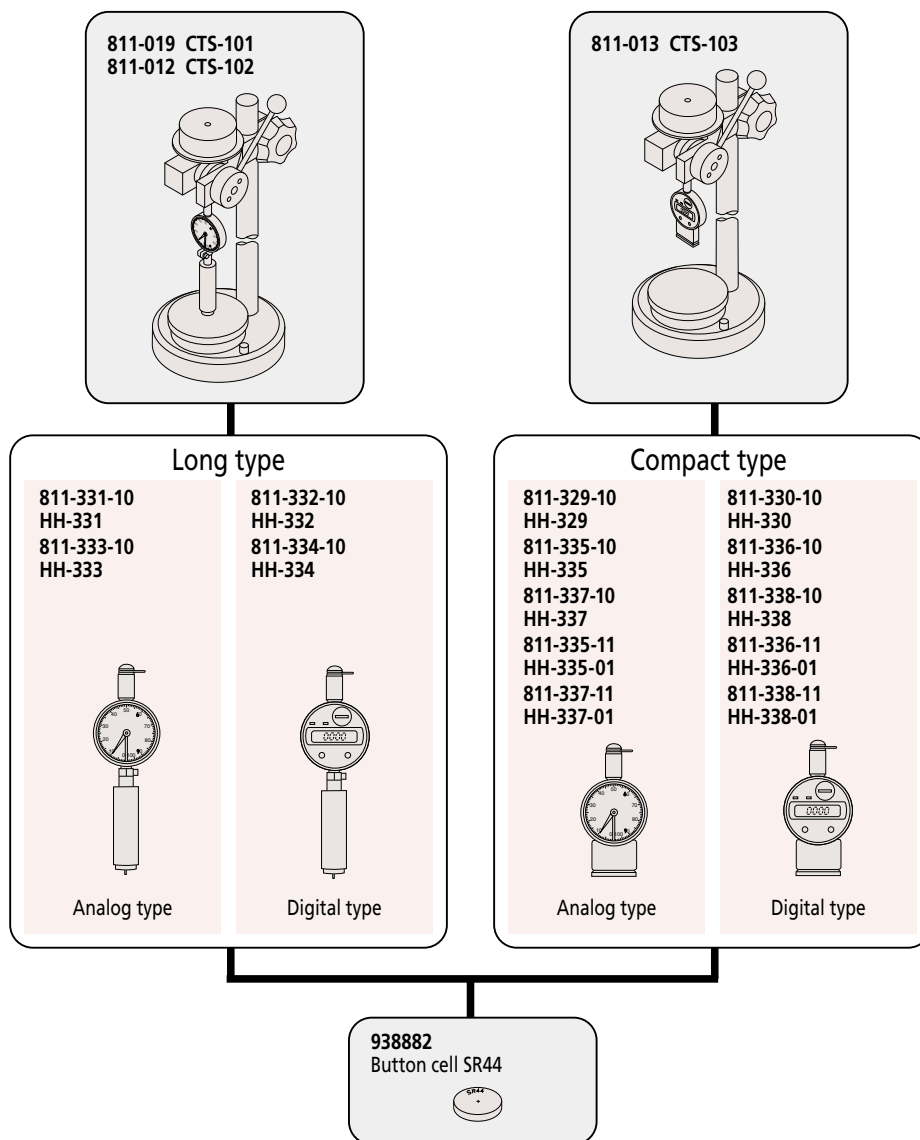

Examples of hardness measurement performance in various standards

Standard	Designation	Description
JIS K 6253	A45/15	Hardness measurement is performed with the Type A hardness tester. It indicates that a hardness measurement of 45 is obtained 15 seconds after starting the measurement.
ISO 7619	D70/10	Hardness measurement is performed with the Type D hardness tester. It indicates that a hardness measurement of 70 is obtained 10 seconds after starting the measurement.
JIS K 7215	HDA83	Hardness measurement is performed with the Type A hardness tester. It indicates that a hardness measurement of 83 is obtained.
	HDD56	Hardness measurement is performed with the Type D hardness tester. It indicates that a hardness measurement of 56 is obtained.
ASTM D 2240	A/45/15	Hardness measurement is performed with the Type A hardness tester. It indicates that a hardness measurement of 45 is obtained 15 seconds after starting the measurement.
	D/60/1	Hardness measurement is performed with the Type D hardness tester. It indicates that a hardness measurement of 60 is obtained 1 second after starting the measurement.
ISO 868	A/15:45	Hardness measurement is performed with the Type A hardness tester. It indicates that a hardness measurement of 45 is obtained 15 seconds after starting the measurement.
	D/1:60	Hardness measurement is performed with the Type D hardness tester. It indicates that a hardness measurement of 60 is obtained 1 second after starting the measurement.
DIN 53 505	75 Shore A	Hardness measurement is performed with the Shore A hardness tester. It indicates that a hardness measurement of 75 is obtained.

Domestic and overseas standards

JIS K 6253-3	"Hardness testing methods for rubber, vulcanized or thermoplastic"
JIS K 7215	"Testing Methods for Durometer Hardness of Plastics"
JIS S 6050	"Plastics erasers"
ISO 7619	"Rubber-Determination of indentation hardness by means of pocket hardness meters"
ISO 868	"Plastics and ebonite-Determination of indentation hardness by means of a durometer (Shore hardness)"
ASTM D 2240	"Standard Test Method for Rubber Property-Durometer Hardness"
DIN 53 505	"Testing of rubber and plastics; shore A and shore D hardness test"
SRIS 0101	"Physical testing methods for expanded rubber"

Data processing software for Hardness testing machines EXPAK

Features of EXPAK software

- It can capture measurement results from the hardness testing machine and display them in Excel worksheets.
- On the worksheets, the measurement results can be easily converted into table format.
- If it is connected to a hardness testing machine that outputs the hardness measurement results and measurement position information together, the hardness distribution on the specimen surface can be displayed graphically. This is very useful in examining the thermal effects of welding, process hardening of the specimen surface, and evaluation of the degree of residual stress.
- A template file suitable for evaluating a carburized hardened layer, a test often used on steel, is supplied.

System configuration

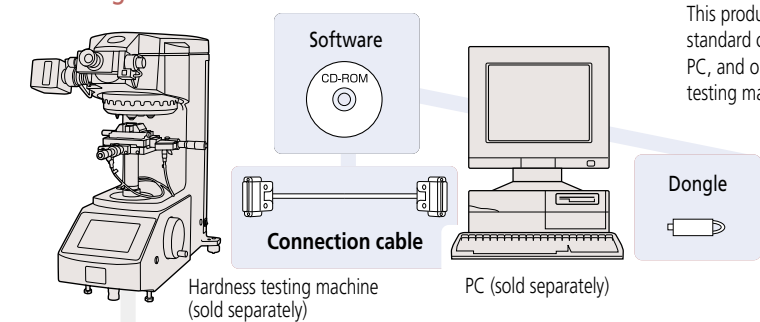

This product consists of the system disk that contains the software as described in the standard configuration, dongle, cables connecting the hardness testing machine and PC, and operation manual. To use this software, you need to purchase a hardness testing machine and PC separately.

Configuration of the data processing software for hardness testing machines

◆ Standard configuration

Measurement result list	Hardness curve
Statistical calculation (maximum, minimum, standard deviation, variation, mean, coefficient of variation)	Hardness histogram 2D hardness distribution 3D hardness distribution

◆ Cable specifications

This software includes the cable that connects the hardness testing machine and PC as a standard accessory.

Note: The cable specification varies depending on your PC and hardness testing machine.

◆ Supported models

Vickers hardness testing machine	Rockwell hardness testing machine
HM-100 Series (except HM-101)	HR-530 Series
HM-200 Series System A	HR-600 Series
HV-100 Series System A	(Excluding PC specifications)
	Portable hardness tester
	HH-411 Series

Specifications

Order No.	Model	Standard configuration	Cable connections		Cable specifications
			Hardness testing machine	Operating environment	
11AAC236	EXPAK-06	· Software CD-ROM (includes user's manual)	HM-210A HM-220A HV-110A/120A HR-530/HR-530L HR-610A/610B/620B (Cannot be used with PC-spec systems)	OS: Microsoft® Windows10 (64 bit) V6.110 or later Application: Microsoft® Excel 2013/2016/2019 Office 2019 (32 bit) V6.400 or later Language: Japanese or English Recommended hardware CPU: Intel i3-2100 processor (3.1 GHz) or more Memory: 2 GB or more Optical drive: CD-ROM drive Required interfaces and no. of ports: 11AAC236: USB, 2 ports 11AAC237, 238: USB, 1 port and RS-232C ^{*2} , 1 port	USB cable
11AAC237	EXPAK-07	· Connection cable · USB security dongle · Quick reference guide	HM-102/103 (Can be used for old models as well.) ^{*1}		RS-232C reverse cable 9P-9P
11AAC238	EXPAK-08		HH-411 (UD-410)		Special connection cable 8P-9P

^{*1} Old models are **HM-112/113/114/115/122/123/124/125/211/221** and **HV-112/113/114/115**, **HR-521/522/523** (except for system machines such as automatic machines with PC).

^{*2} Mitutoyo is unable to provide assurance for use of RS-232C with a commercial USB-RS-232C converter as performance has not been tested.

Examples of setting screens

The following are sample screenshots of data processing software for hardness testing machines running within an Excel* worksheet.

* Excel is either a registered trademark or trademark of Microsoft Corporation in the United States and/or other countries

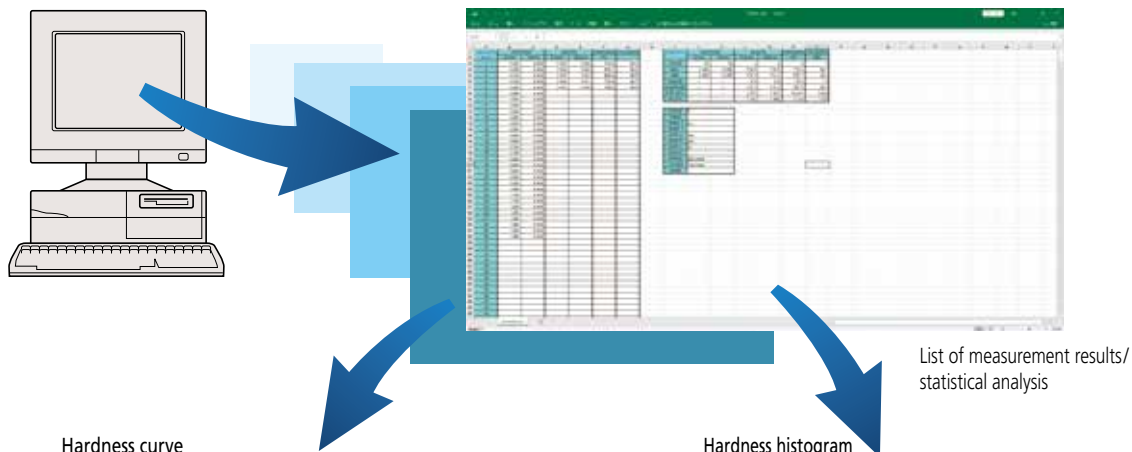

Hardness curve

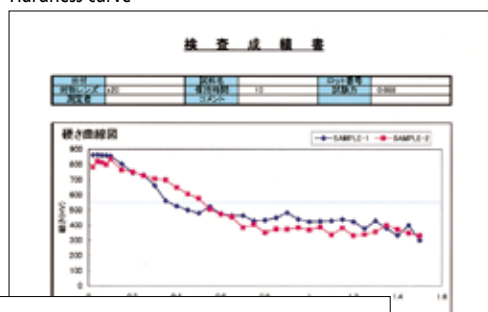

Hardness histogram

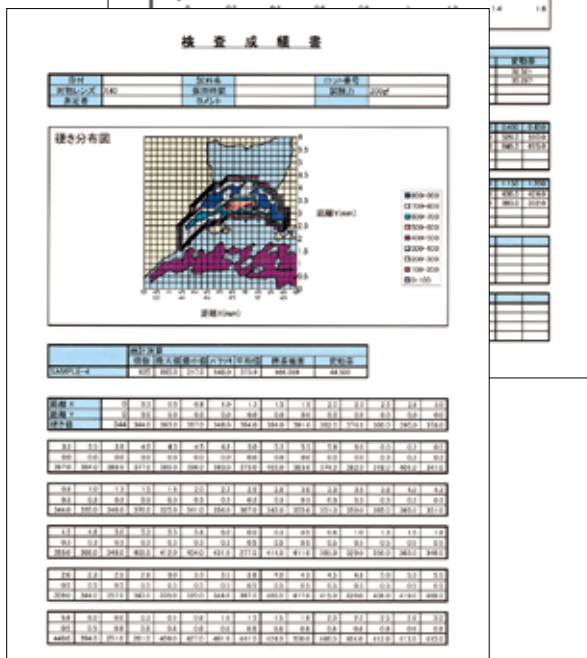
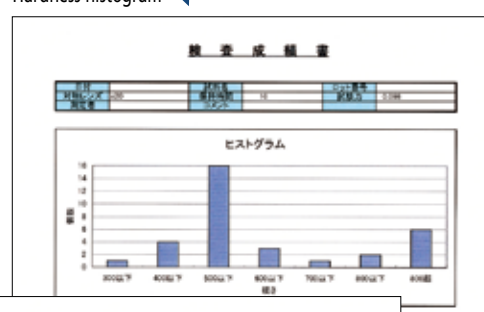

2D hardness distribution

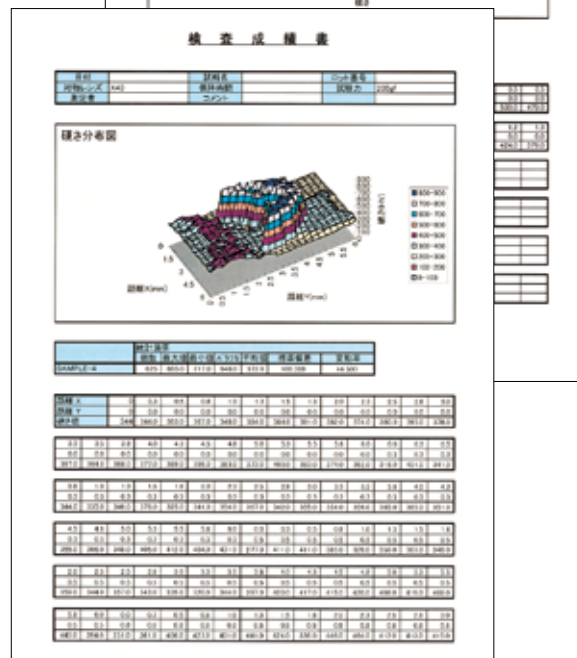

3D hardness distribution

Note: 3D hardness distribution is not a basic function of this product and uses functions of Microsoft Excel software.

Measurement Data Network System MeasurLink®

Achieve “Visualization of Quality”



What is MeasurLink®?

MeasurLink® is an IoT platform for quality management that realizes “Visualization of Quality” by enabling real-time data collection from the networked Digimatic gages and global control and analysis. U-WAVE supports MeasurLink® as an infrastructure that collects and controls data.

Preventing defectives
Collects data from the Digimatic gages on the network and performs statistical process control (SPC) to warn of possible generation of defectives.

Diagnosis by data analysis
Checking measurement results by accessing the data base and performing various analyses helps investigate and resolve process performance concerns.

Simply start achieving IoT
In addition to conventional data storage, the network can be configured in steps to simply start IoT of Quality Control.

Linkage between U-WAVE and MeasurLink®

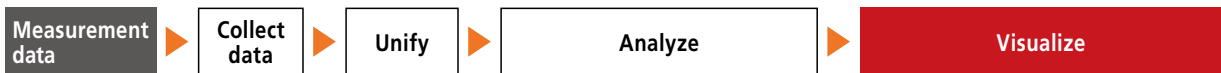
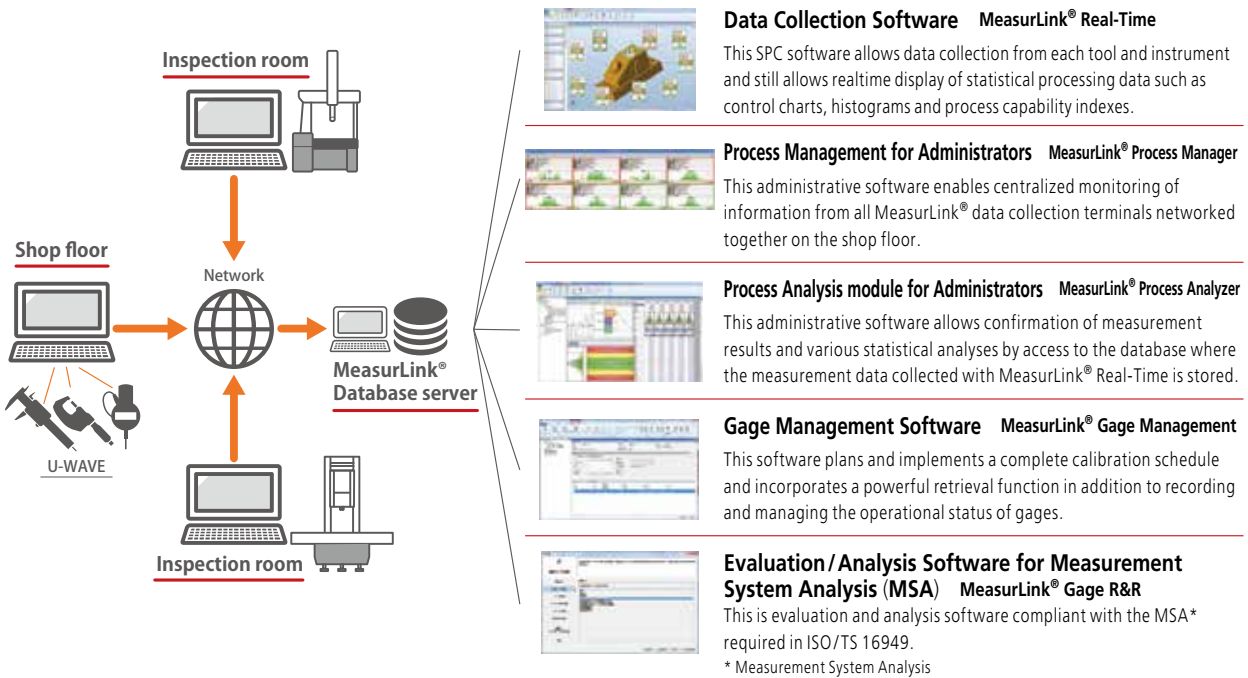

MeasurLink® is a registered trademark of Mitutoyo Corporation in Japan and Mitutoyo America Corporation in the United States.

Mini-Printer Equipped with Data Logging Function Digimatic Mini-Processor DP-1VA LOGGER

- This is a palm-sized printer used to print measurement data from Digimatic gages or to perform statistical analysis.
- The versatile **DP-1VA LOGGER** printer not only prints measurement data, but performs a variety of statistical analyses, draws histograms and D-charts and also performs complex operations on \bar{X} -R control charts.
- The data logger function allows storage of up to 1,000 pieces of data in memory, and batch transfer of stored data to an Excel-format inspection certificate, etc., by connecting to a PC with a USB cable (optional).
- Cable for connection to hardness testing machine is not included. A connection cable (sold separately) is required. For the appropriate cable refer to the accessories list for the machine in question or contact Mitutoyo Sales Dept.



264-505
DP-1VA LOGGER

Various cables

USB cable (A-microB)	06AFZ050
Connection cable (1 m) Type D	936937
Connection cable (1 m) Type E	937387
Connection cable (1 m) Type D (EMC test type)	12AAJ112



Measurement Data Wireless Communication System U-WAVE

- Data from a hardness testing machine with Digimatic output function can be imported wirelessly to a PC.
- Wireless communication (up to 20 meters) makes for easy installation without any obstruction from cables.
- Using the software included as standard with **U-WAVE-R**, data can be written to (Excel, Notepad, etc.) using common keyboard input.
- **U-WAVE** can communicate simultaneously with multiple **U-WAVE-T** units, so test results from multiple hardness testing machines can be imported to a single PC.



U-WAVE-R
02AZD810D

U-WAVE-T
IP67 type: 02AZD730G
Buzzer type: 02AZD880G

U-WAVE-T connection cable

U-WAVE-T dedicated connection cable	Type D	02AZD790D
U-WAVE-T dedicated connection cable	Type E	02AZD790E



Related information and materials

Hardness basics

“Hardness” is a convenient term used broadly in our daily language, but the concept is complicated. Experiencing hard and soft is easy, but it is difficult to express those actual qualities in simple terms. Hardness thus has broad meanings and refers to a measure closely related to one or a number of properties, including resistance to wear, resistance to scratching, elastic modulus, yield point, fracture strength, viscosity, brittleness, and ductility. Hardness testing is localized testing of a material and is therefore easier to perform than testing of other properties like tensile strength, proof stress, spring elastic limit, formability and abrasion resistance. Even after testing, it is often the case that the item can still be used as a product. Therefore testing hardness is often preferred as a practical alternative to testing other characteristics.

Hardness is not a physical quantity like length, time, mass or current, but an industrial quantity or comparison value like other mechanical properties.

The hardness of an object is a measure indicating the level of resistance when the object is subjected to deformation by another object.

1. Overview of hardness

Testing methods used to characterize hardness as a numerical value employ diverse methods of applying deformation and resistance representation devised for, and defined by, each of those testing methods. The hardness testing methods used by industry today can be basically grouped as follows according to variations in standard materials, deformations to be used as the basis for measurement, and hardness calculation methods. Indentation testing methods are the most commonly applied. They involve applying a permanent deformation to the test surface and determining its hardness from the test force required to create the deformation and the size of the deformation.

Rebound hardness (or dynamic hardness) testing measures the behavior when a standard impactor is made to collide with the test surface, and scratch hardness testing measures the behavior when two materials are rubbed together. Portable hardness testing employs a different comparative measurement method for each type of material due to priority being placed on ease of operation and even magnetism and ultrasound are used.

Other typical examples of methods for common hardnesses include Mohs hardness and pencil hardness testing, which have been around for many years.

2. Hardness-related standards

Japanese Industrial Standards (JIS) include a number of standards related to hardness. With the recent trend toward internationalization, JIS standards are being revised so they are consistent with ISO standards. The major categories can be grouped as follows.

- Test methods: Specifying the methods to be used for general hardness testing
- Verification of testing machines: Specifying the testing machines to be used for hardness testing
- Calibration of reference blocks: Specifying the methods of calibration of reference blocks to be used for verification of hardness testing machines
- Application-specific test methods: Specifying the hardness testing methods to be used for specific applications.

• Brinell hardness testing

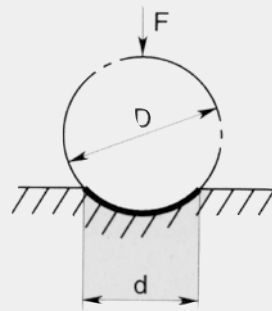

• Vickers hardness testing

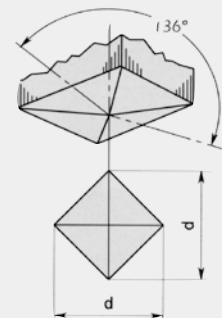

• Rockwell hardness testing

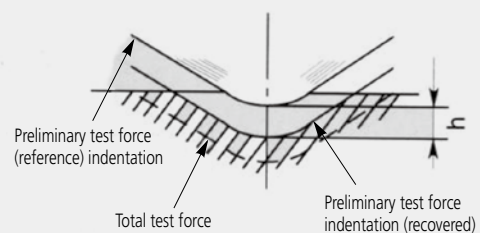

Indentation size for each type of hardness test

Hardness test	Test force	Indentation diameter (mm)	Indentation depth (mm)
Brinell hardness (HB)	29421 N	5.5 to 3	1 to 0.5
Rockwell hardness (HRC)	1471 N	1 to 0.5	0.06 to 0.015
Rockwell hardness (HRA)	588.4 N	0.5 to 0.25	0.04 to 0.01
Rockwell Superficial hardness (HR)	147.1 to 441.3 N	0.2 to 0.02	0.02 to 0.001
Vickers hardness (HV)	9.807 to 490.3 N	0.7 to 0.05	0.1 to 0.01
	98.07 to 9807 mN	0.2 to 0.005	0.03 to 0.001
Shore hardness (HS)		0.3 to 0.6	0.01 to 0.04

Hardness definitions and types

Types of "hardness"

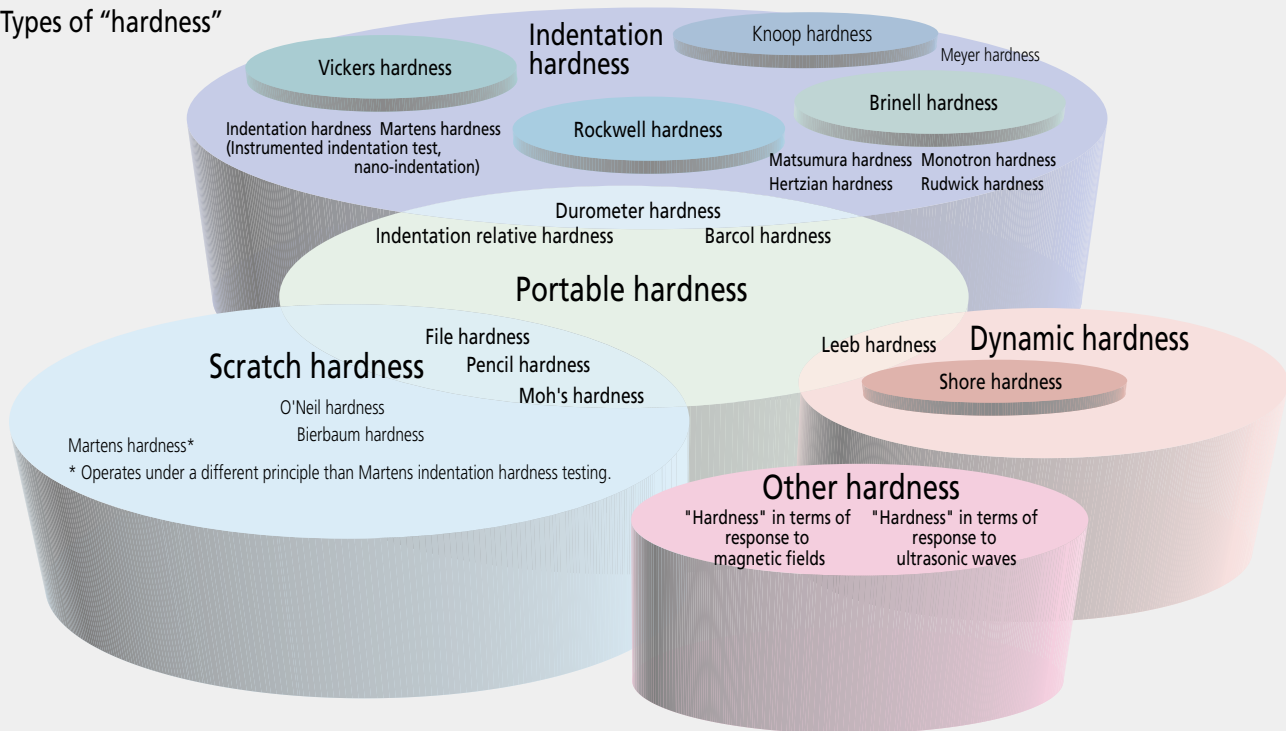

Definition of hardness

(1) Brinell hardness

The Brinell hardness testing method was the first method invented for standardizing hardness, from which other hardness measuring methods have been derived. Brinell hardness is the test force F divided by the contact area S (mm^2) between the spherical indenter and specimen calculated on the diameter d (mm) of the impression made when the indenter (a steel ball or cemented carbide ball with a diameter D mm) is pressed into the sample by the test force F and then removed. The symbol HBS is used when the indenter is a steel ball, or HBW when it is a cemented carbide ball. k is a constant ($1/g=1/9.80665=0.102$).

$$HBW = k \frac{F}{S} = 0.102 \frac{2F}{\pi D (D - \sqrt{D^2 - d^2})} \quad \begin{array}{l} F: \text{N} \\ D: \text{mm} \\ d: \text{mm} \end{array}$$

For the same loading condition (F/D^2), the Brinell hardness obtained is almost the same when different test forces are used for measurement. In many countries, measurement with small test forces is widespread as an application of this fact. Testing with a test force of 2451 N or less can be conducted by using the test force weight and indenter for the Rockwell or Vickers hardness testing machine. For steel, F/D^2 is 30. For other softer materials, an appropriate value is selected from 15, 10, 5, 2.5, and 1. In the JIS and ISO standards, the test force is 9.807 to 29420 N, and the diameter of the spherical indenter is 1 to 10 mm. An error of the Brinell hardness test is obtained by the following formula. Δd_1 indicates the error of the impression measuring device, Δd_2 the error in impression measurement.

$$\frac{\Delta HB}{HB} \approx -\frac{\Delta F}{F} - (0.03 \text{ to } 0.18) \frac{\Delta D}{D} - 2 \frac{\Delta d_1}{d} - 2 \frac{\Delta d_2}{d}$$

(2) Vickers hardness

Vickers hardness is the most versatile test method as it can be used with any test force. More specifically, there are many applications of microhardness below 9.807 N. Vickers hardness is the test force F divided by the area S (mm^2) of the indenter and sample calculated based on the diagonal length d (the average of 2 directions in mm) of the impression made when the pyramid-shaped diamond indenter ($\theta=136^\circ$ between opposite faces) is pressed into the sample by the test force F (N) and then removed.

$$HV = k \frac{F}{S} = 0.102 \frac{F}{S} = 0.102 \frac{2F \sin \frac{\theta}{2}}{d^2} = 0.1891 \frac{F}{d^2} \quad \begin{array}{l} F: \text{N} \\ d: \text{mm} \end{array}$$

An error of the Vickers hardness test is obtained by the following formula. Δd_1 indicates the measuring error of the microscope, Δd_2 indicates the error in indentation measurement, " a " indicates the length of the edge line between two opposite faces at the tip of the indenter. $\Delta \theta$ is in degrees.

$$\frac{\Delta HV}{HV} \approx -\frac{\Delta F}{F} - 2 \frac{\Delta d_1}{d} - 2 \frac{\Delta d_2}{d} - \frac{a^2}{d^2} - 3.5 \times 10^{-3} \Delta \theta$$

(3) Knoop hardness

Knoop hardness is the test force F divided by the projected area A (mm^2) of the impression calculated based on the longer diagonal length d (mm) of the indentation made when the pyramid-shaped diamond indenter with apical angles of 130° and $172^\circ 30'$ and rhomboid cross section is pressed into the specimen by the test force F and then removed. Knoop hardness can be measured by replacing the Vickers indenter of the microhardness testing machine with the Knoop indenter.

$$HK = k \frac{F}{A} = 0.102 \frac{F}{A} = 0.102 \frac{F}{cd^2} = 1.451 \frac{F}{d^2} \quad \begin{array}{l} F: \text{N} \\ d: \text{mm} \end{array}$$

(4) Rockwell hardness and Rockwell Superficial hardness

A conical diamond indenter with an angle of 120° and a tip radius of 0.2 mm tip or spherical indenter (steel or cemented carbide) is used. The preliminary test force is applied first, the test force is applied, and then the preliminary test force is applied again. Rockwell hardness and Rockwell Superficial hardness can be obtained from the hardness calculation formula based on the difference in depths of impression h (μm) measured at the first and second application of the initial test force. The hardness is called Rockwell hardness when the preliminary test force is 98.07 N, or Rockwell Superficial hardness when it is 29.42 N. Unique symbols are assigned to combinations of types of the indenter, test forces, and hardness calculation formula, which comprise a scale. JIS defines scales of hardness.

$$\begin{array}{ll} \text{HR (Diamond indenter, Rockwell hardness)} = 100 - h/0.002 & h: \text{mm} \\ \text{HR (Ball indenter, Rockwell hardness)} = 130 - h/0.002 & h: \text{mm} \\ \text{HR (Diamond/Ball indenter, Rockwell Superficial hardness)} = 100 - h/0.001 & h: \text{mm} \end{array}$$

Relation diagram for specimen hardness and minimum thickness

Vickers

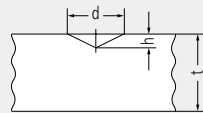

$$HV = 0.1891 \frac{F}{d^2}$$

$$t > 1.5d$$

$$h \approx d/7$$

t: Thickness of specimen mm

d: Diagonal length mm

h: Depth of indentation mm

Vickers hardness
HV

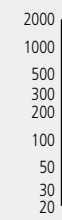

Minimum thickness of specimen
t: mm

Diagonal length of indentation
d: mm

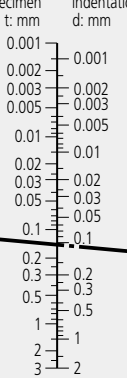

[Example]

Specimen thickness t: 0.15 mm

Specimen hardness: 185 HV1

Test force F: 9.807 N (1 kgf)

Diagonal length d: 0.1 mm

Hardness symbol	Test force F: N
HV0.00005	49.03×10 ⁻⁵
0.0001	98.07×10 ⁻⁵
0.0002	19.61×10 ⁻⁴
0.0003	29.42×10 ⁻⁴
0.0005	49.03×10 ⁻⁴
0.001	98.07×10 ⁻⁴
0.002	19.61×10 ⁻³
0.003	29.42×10 ⁻³
0.005	49.03×10 ⁻³
0.01	98.07×10 ⁻³
0.02	0.1961
0.03	0.2942
0.05	0.4903
0.1	0.9807
0.2	1.961
0.3	2.942
0.5	4.903
1	9.807
2	19.61
3	29.42
5	49.03
10	98.07
20	196.1
30	294.2
50	490.3

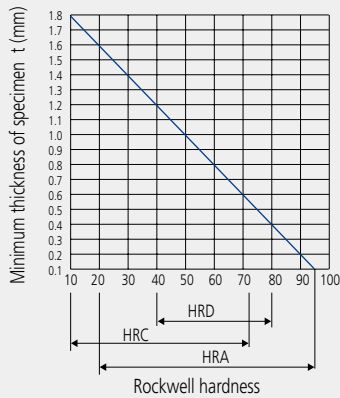

Rockwell
Rockwell Superficial hardness

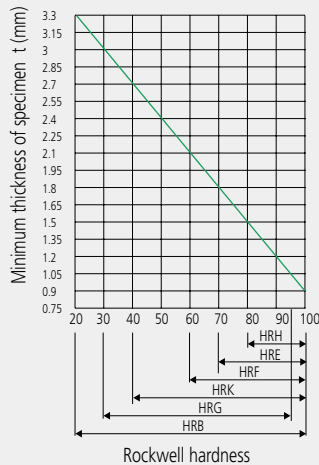

Rockwell hardness

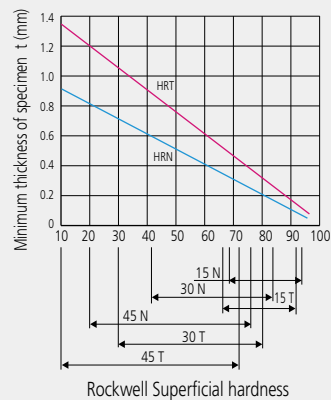

Rockwell Superficial hardness

Types of Rockwell hardness

Scale	Indenter	Test force	Application
A	Diamond	588.4 N	Carbide, sheet steel
D		980.7 N	Case-hardened steel
C		1471 N	Steel (100 HRB or more to 70 HRC or less)
F	Sphere of 1.5875 mm diameter	588.4 N	Bearing metal, annealed copper
B		980.7 N	Brass
G		1471 N	Hard aluminum alloy, beryllium copper, phosphor bronze
H	Sphere of 3.175 mm diameter	588.4 N	Bearing metal, grind stone
E		980.7 N	Bearing metal
K		1471 N	Bearing metal
L	Sphere of 6.35 mm diameter	588.4 N	Plastic, lead
M		980.7 N	
P		1471 N	
R	Sphere of 12.7 mm diameter	588.4 N	Plastic
S		980.7 N	
V		1471 N	

Types of Rockwell Superficial hardness

Scale	Indenter	Test force	Application
15-N	Diamond	147.1 N	Thin surface-hardened layer on steel such as carburized or nitrided
30-N		294.2 N	
45-N		441.3 N	
15-T	Sphere of 1.5875 mm diameter	147.1 N	Sheet of mild steel, brass, bronze, etc.
30-T		294.2 N	
45-T		441.3 N	
15-W	Sphere of 3.175 mm diameter	147.1 N	Plastic, zinc, bearing alloy
30-W		294.2 N	
45-W		441.3 N	
15-X	Sphere of 6.35 mm diameter	147.1 N	Plastic, zinc, bearing alloy
30-X		294.2 N	
45-X		441.3 N	
15-Y	Sphere of 12.7 mm diameter	147.1 N	Plastic, zinc, bearing alloy
30-Y		294.2 N	
45-Y		441.3 N	

Hardness conversion table

The table below enables conversion between hardness values for metals, which vary according to the particular standard. For accurate results, please use values obtained with the respective testing machines as reference.

• Steel

Vickers	Rockwell				Rockwell Superficial			Shore
	HV	HRA	HRB	HRC	HRD	15N	30N	
940	85.6	—	68.0	76.9	93.2	84.4	75.4	98.0
920	85.3	—	67.5	76.5	93.0	84.0	74.8	96.8
900	85.0	—	67.0	76.1	92.9	83.6	74.2	95.6
880	84.7	—	66.4	75.7	92.7	83.1	73.6	94.3
860	84.4	—	65.9	75.3	92.5	82.7	73.1	93.1
840	84.1	—	65.3	74.8	92.3	82.2	72.2	91.7
820	83.8	—	64.7	74.3	92.1	81.7	71.8	90.4
800	83.4	—	64.0	73.8	91.8	81.1	71.0	89.0
780	83.0	—	63.3	73.3	91.5	80.4	70.2	87.7
760	82.6	—	62.5	72.6	91.2	79.7	69.4	86.2
740	82.2	—	61.8	72.1	91.0	79.1	68.6	84.8
720	81.8	—	61.0	71.5	90.7	78.4	67.7	83.3
700	81.3	—	60.1	70.8	90.3	77.6	66.7	81.8
690	81.1	—	59.7	70.5	90.1	77.2	66.2	81.0
680	80.8	—	59.2	70.1	89.8	76.8	65.7	80.2
670	80.6	—	58.8	69.8	89.7	76.4	65.3	79.4
660	80.3	—	58.3	69.4	89.5	75.9	64.7	78.6
650	80.0	—	57.8	69.0	89.2	75.5	64.1	77.8
640	79.8	—	57.3	68.7	89.0	75.1	63.5	77.0
630	79.5	—	56.8	68.3	88.8	74.6	63.0	76.2
620	79.2	—	56.3	67.9	88.5	74.2	62.4	75.4
610	78.9	—	55.7	67.5	88.2	73.6	61.7	74.5
600	78.6	—	55.2	67.0	88.0	73.2	61.2	73.7
590	78.4	—	54.7	66.7	87.8	72.7	60.5	72.8
580	78.0	—	54.1	66.2	87.5	72.1	59.9	72.0
570	77.8	—	53.6	65.8	87.2	71.7	59.3	71.1
560	77.4	—	53.0	65.4	86.9	71.2	58.6	70.2
550	77.0	—	52.3	64.8	86.6	70.5	57.8	69.3
540	76.7	—	51.7	64.4	86.3	70.0	57.0	68.4
530	76.4	—	51.1	63.9	86.0	69.5	56.2	67.5
520	76.1	—	50.5	63.5	85.7	69.0	55.6	66.6
510	75.7	—	49.8	62.9	85.4	68.3	54.7	65.6
500	75.3	—	49.1	62.2	85.0	67.7	53.9	64.7
490	74.9	—	48.4	61.6	84.7	67.1	53.1	63.7
480	74.5	—	47.7	61.3	84.3	66.4	52.2	62.8
470	74.1	—	46.9	60.7	83.9	65.7	51.3	61.8
460	73.6	—	46.1	60.1	83.6	64.9	50.4	60.8
450	73.3	—	45.3	59.4	83.2	64.3	49.4	59.8
440	72.8	—	44.5	58.8	82.8	63.5	48.4	58.8
430	72.3	—	43.6	58.2	82.3	62.7	47.4	57.8
420	71.8	—	42.7	57.5	81.8	61.9	46.4	56.7
410	71.4	—	41.8	56.8	81.4	61.1	45.3	55.7
400	70.8	—	40.8	56.0	81.0	60.2	44.1	54.6
390	70.3	—	39.8	55.2	80.3	59.3	42.9	53.6
380	69.8	(110.0)	38.8	54.4	79.8	58.4	41.7	52.5
370	69.2	—	37.7	53.6	79.2	57.4	40.4	51.4
360	68.7	(109.0)	36.6	52.8	78.6	56.4	39.1	50.3
350	68.1	—	35.5	51.9	78.0	55.4	37.8	49.2
340	67.6	(108.0)	34.4	51.1	77.4	54.4	36.5	48.1
330	67.0	—	33.3	50.2	76.8	53.6	35.2	46.9
320	66.4	(107.0)	32.2	49.4	76.2	52.3	33.9	45.7
310	65.8	—	31.0	48.4	75.6	51.3	32.5	44.6
300	65.2	(105.5)	29.8	47.5	74.9	50.2	31.1	43.4
295	64.8	—	29.2	47.1	74.6	49.7	30.4	42.8
290	64.5	(104.5)	28.5	46.5	74.2	49.0	29.5	42.2
285	64.2	—	27.8	46.0	73.8	48.4	28.7	41.6
280	63.8	(103.5)	27.1	45.3	73.4	47.8	27.9	41.0
275	63.5	—	26.4	44.9	73.0	47.2	27.1	40.4
270	63.1	(102.0)	25.6	44.3	72.6	46.4	26.2	39.7
265	62.7	—	24.8	43.7	72.1	45.7	25.2	39.1
260	62.4	(101.0)	24.0	43.1	71.6	45.0	24.3	38.5
255	62.0	—	23.1	42.2	71.1	44.2	23.2	37.9
250	61.6	99.5	22.2	41.7	70.6	43.4	22.2	37.2
245	61.2	—	21.3	41.1	70.1	42.5	21.1	36.6
240	60.7	98.1	20.3	40.3	69.6	41.7	19.9	36.0
230	—	96.7	(18.0)	—	—	—	—	34.7
220	—	95.0	(15.7)	—	—	—	—	33.4
210	—	93.4	(13.4)	—	—	—	—	32.0
200	—	91.5	(11.0)	—	—	—	—	30.7
190	—	89.5	(8.5)	—	—	—	—	29.4
180	—	87.1	(6.0)	—	—	—	—	28.0
170	—	85.0	(3.0)	—	—	—	—	26.6
160	—	81.7	(0.0)	—	—	—	—	25.2
150	—	78.7	—	—	—	—	—	23.8
140	—	75.0	—	—	—	—	—	22.3
130	—	71.2	—	—	—	—	—	20.8
120	—	66.7	—	—	—	—	—	19.4
110	—	62.3	—	—	—	—	—	17.9
100	—	56.2	—	—	—	—	—	16.3

• This conversion table is compiled based on standard SAE J 417. • Shore hardness follows JIS B7731.

• Brass

Vickers	Rockwell		Rockwell Superficial	
	HV	HRB	HRF	30T
196	93.5	110.0	77.5	66.0
194	—	109.5	—	65.5
192	93.0	—	77.0	65.0
190	92.5	109.0	76.5	64.5
188	92.0	—	—	64.0
186	91.5	108.5	76.0	63.5
184	91.0	—	75.5	63.0
182	90.5	108.0	—	62.5
180	90.0	107.5	75.0	62.0
178	89.0	—	74.5	61.5
176	88.5	107.0	—	61.0
174	88.0	—	74.0	60.5
172	87.5	106.5	73.5	60.0
170	87.0	—	—	59.5
168	86.0	106.0	73.0	59.0
166	85.5	—	72.5	58.5
164	85.0	105.5	72.0	58.0
162	84.0	105.0	—	57.5
160	83.5	—	71.5	56.5
158	83.0	104.5	71.0	56.0
156	82.0	104.0	70.5	55.5
154	81.5	103.5	70.0	54.5
152	80.5	103.0	—	54.0
150	80.0	—	69.5	53.5
148	79.0	102.5	69.0	53.0
146	78.0	102.0	68.5	52.5
144	77.5	101.5	68.0	51.5
142	77.0	101.0	67.5	51.0
140	76.0	100.5	67.0	50.0
138	75.0	100.0	66.5	49.0
136	74.5	99.5	66.0	48.0
134	73.5	99.0	65.5	47.5
132	73.0	98.5	65.0	46.5
130	72.0	98.0	64.5	45.5
128	71.0	97.5	63.5	45.0
126	70.0	97.0	63.0	44.0
124	69.0	96.5	62.5	43.0
122	68.0	96.0	62.0	42.0
120	67.0	95.5	61.0	41.0
118	66.0	95.0	60.5	40.0
116	65.0	94.5	60.0	39.0
114	64.0	94.0	59.5	38.0
112	63.0	93.0	58.5	37.0
110	62.0	92.6	58.0	35.5
108	61.0	92.0	57.0	34.5
106	59.5	91.2	56.0	33.0
104	58.0	90.5	55.0	32.0
102	57.0	89.8	54.5	30.5
100	56.0	89.0	53.5	29.5
98	54.0	88.0	52.5	28.0
96	53.0	87.2	51.5	26.5
94	51.0	86.3	50.5	24.5
92	49.5	85.4	49.0	23.0
90	47.5	84.4	48.0	21.0
88	46.0	83.5	47.0	19.0
86	44.0	82.3	45.5	17.0
84	42.0	81.2	44.0	14.5
82	40.0	80.0	43.0	12.5
80	37.5	78.6	41.0	10.0
78	35.0	77.4	39.5	7.5
76	32.5	76.0	38.0	4.5
74	30.0	74.8	36.0	1.0
72	27.5	73.2	34.0	—
70	24.5	71.8	32.0	—
68	21.5	70.0	30.0	—
66	18.5	68.5	28.0	—
64	15.5	66.8	25.5	—
62	12.5	65.0	23.0	—
60	10.0	62.5	—	—
58	—	61.0	18.0	—
56	—	58.8	15.0	—
54	—	56.5	12.0	—
52	—	53.5	—	—
50	—	50.5	—	—
49	—	49.0	—	—
48	—	47.0	—	—
47	—	45.0	—	—
46	—	43.0	—	—
45	—	40.0	—	—

• This conversion table is compiled based on standard ASTM E140 TABLE 4.

Related hardness standards

JIS	Name	Hardness used (scale)
B 7724-99	Brinell hardness test – Verification of testing machines	HB
B 7725-10	Vickers hardness test – Verification and calibration of testing machines	HV
B 7726-10	Rockwell hardness test – Verification and calibration of testing machines and indenters	HR
B 7727-00	Shore hardness test – Verification of testing machines	HS
B 7730-10	Rockwell hardness test – Calibration of standard blocks	HR
B 7731-00	Shore hardness test – Calibration of standard blocks	HS
B 7734-97	Knoop hardness test – Verification of testing machines	HV, HK
B 7735-10	Vickers hardness test – Calibration of standard blocks	HV
B 7736-99	Brinell hardness test – Calibration of standard blocks	HB
D 4421-96	Hardness test method for brake linings, pads and clutch facings of automobiles	HRM, HRR, HRS, HRV
G 0557-06	Methods of measuring case depth hardened by carburizing treatment for steel	HV
G 0558-07	Steels – Determination of depth of decarburization	HV, HR15N, HR30N
G 0559-08	Steel – Determination of case depth after flame hardening or induction hardening	HV, HRC
G 0561-11	Method of hardenability test for steel (End quenching method)	HV, HRC
G 0562-93	Method of measuring nitrided case depth for iron and steel	HV, HK
G 0563-93	Method of measuring surface hardness for nitrided iron and steel	HV, HK, HR15N, HS
H 0511-07	Test methods for Brinell hardness with titanium and titanium alloy – sponge titanium	HB
K 6250-06	Rubber – General procedures for preparing and conditioning test pieces for physical test methods	
K 6253-1-12	Rubber, vulcanized or thermoplastic – Determination of hardness – Part 1: General guidance	
K 6253-3-12	Rubber, vulcanized or thermoplastic – Determination of hardness – Part 3: Durometer method	
K 6253-5-12	Rubber, vulcanized or thermoplastic – Determination of hardness – Part 5: Calibration and verification	
K 7060-95	Testing method for barcol hardness of glass fiber reinforced plastics	
K 7202-2-01	Plastics – Determination of hardness – Part 2: Rockwell hardness	HRR, HRL, HRM, HRE
K 7215-86	Testing Methods for Durometer Hardness of Plastics	HDA, HDD
R 1607-10	Testing methods for fracture toughness of fine ceramics at room temperature	Kc
S 6050-08	Plastics erasers	
Z 2101-09	Methods of test for woods	HB
Z 2243-08	Brinell hardness test – Test method	HB
Z 2244-09	Vickers hardness test – Test method	HV
Z 2245-11	Rockwell hardness test – Test method	HR
Z 2246-00	Shore hardness test – Test method	HS
Z 2251-09	Knoop hardness test – Test method	HV, HK
Z 2252-91	Test methods for Vickers hardness at elevated temperatures	HV
Z 3101-90	Testing Method of Maximum Hardness in Weld Heat - Affected Zone	HV
Z 3114-90	Method of Hardness Test for Deposited Metal	HV, HRB, HRC
Z 3115-73	Method of Taper Hardness Test in Weld Heat - Affected Zone	HV

Note: Standard numbers/names may be different due to revision of the standards.

Dimensions

Micro Vickers Hardness Testing Machines HM-200 Series

System A

System D

Unit: mm

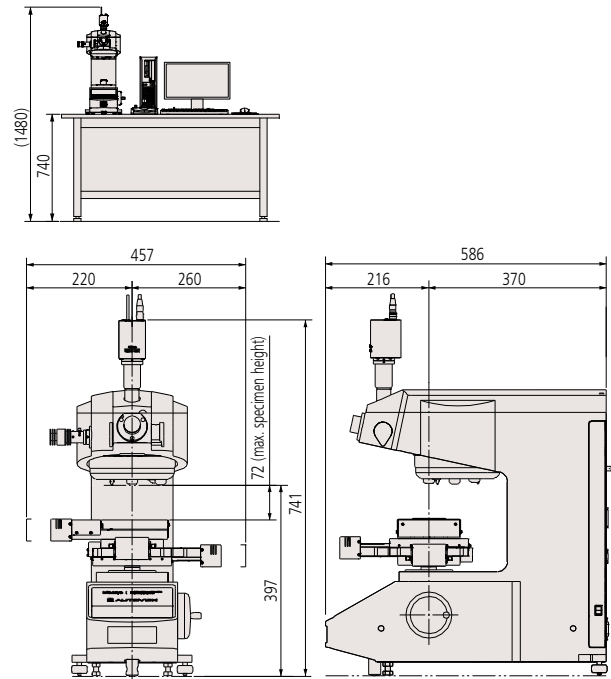
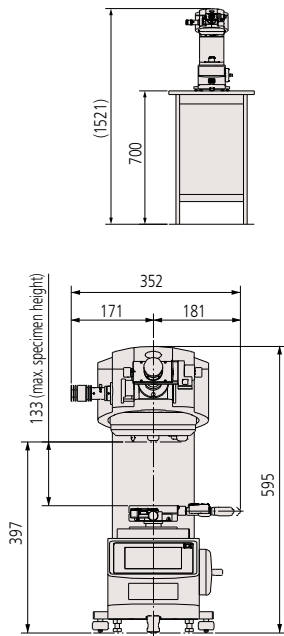

Note 1: When the 25×25 mm manual XY stage is used

Note 2: When the 100×100 mm motorized XY stage is used

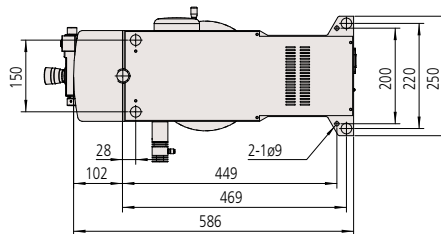

Testing machine bottom view

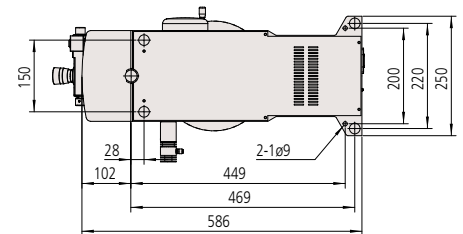

Testing machine bottom view

Micro Vickers Hardness Testing Machines HM-100 Series

Unit: mm

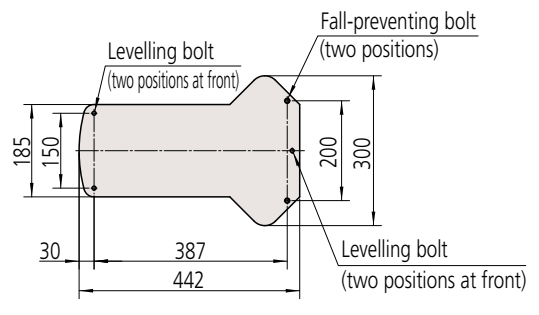
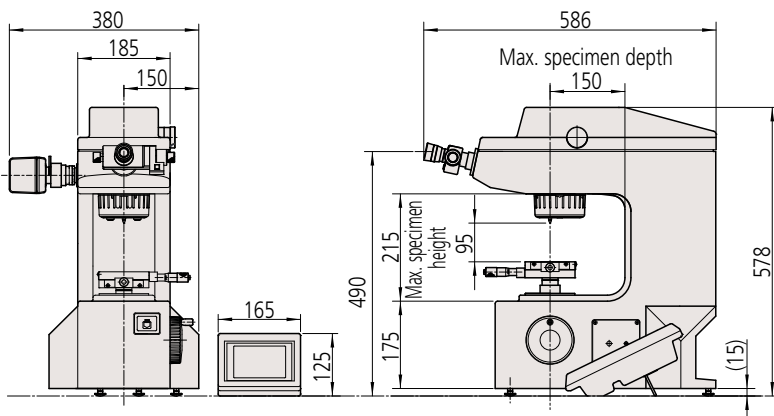

Testing machine bottom view

Dimensions

Vickers Hardness Testing Machines HV-100 Series

System A

System D

Unit: mm

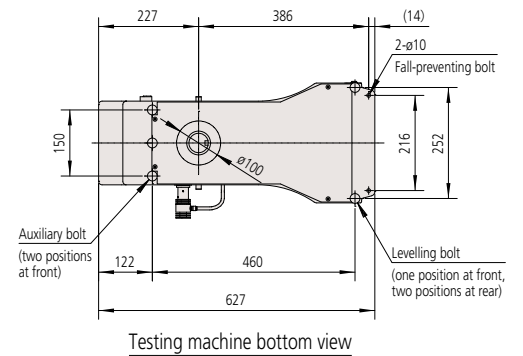
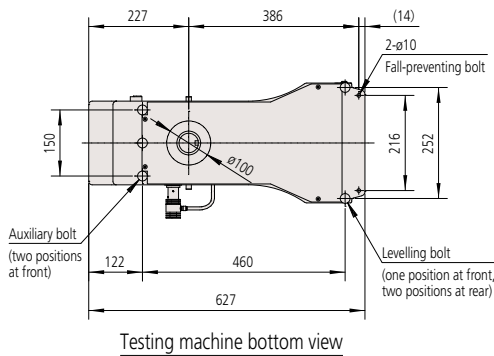
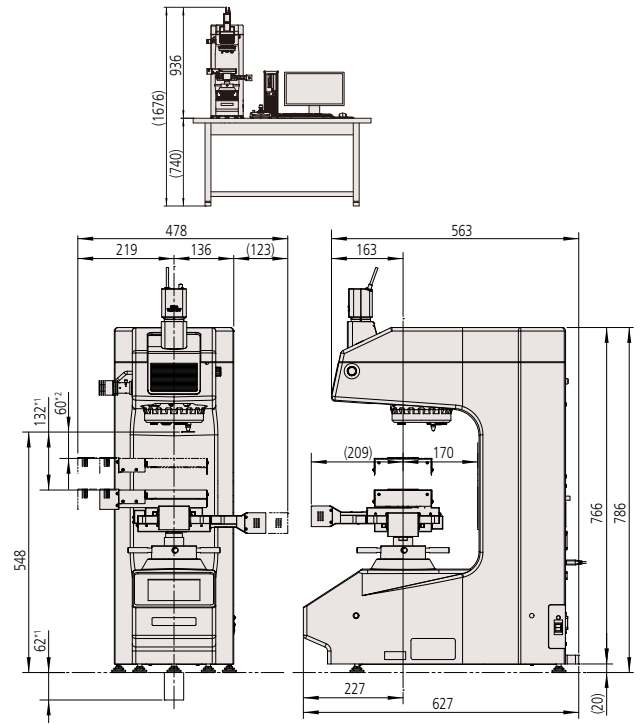
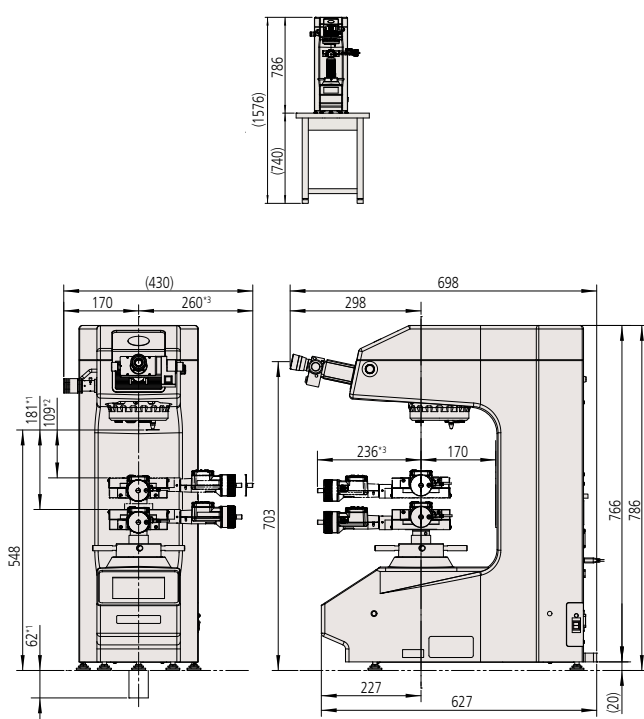

*1 Maximum height of specimen when an escape hole exists below the main shaft in the machine mounting table that allows the shaft to be lowered to the maximum extent.
 *2 Maximum height of specimen when an escape hole does not exist in the machine mounting table.
 *3 Dimension when the manual XY stage unit with 50 mm stroke (optional) is equipped.

*1 Maximum height of specimen when an escape hole exists below the main shaft in the machine mounting table that allows the shaft to be lowered to the maximum extent.
 *2 Maximum height of specimen when an escape hole does not exist in the machine mounting table.

Rockwell Hardness Testing Machines HR-200/300/400 Series

HR-210MR

Unit: mm

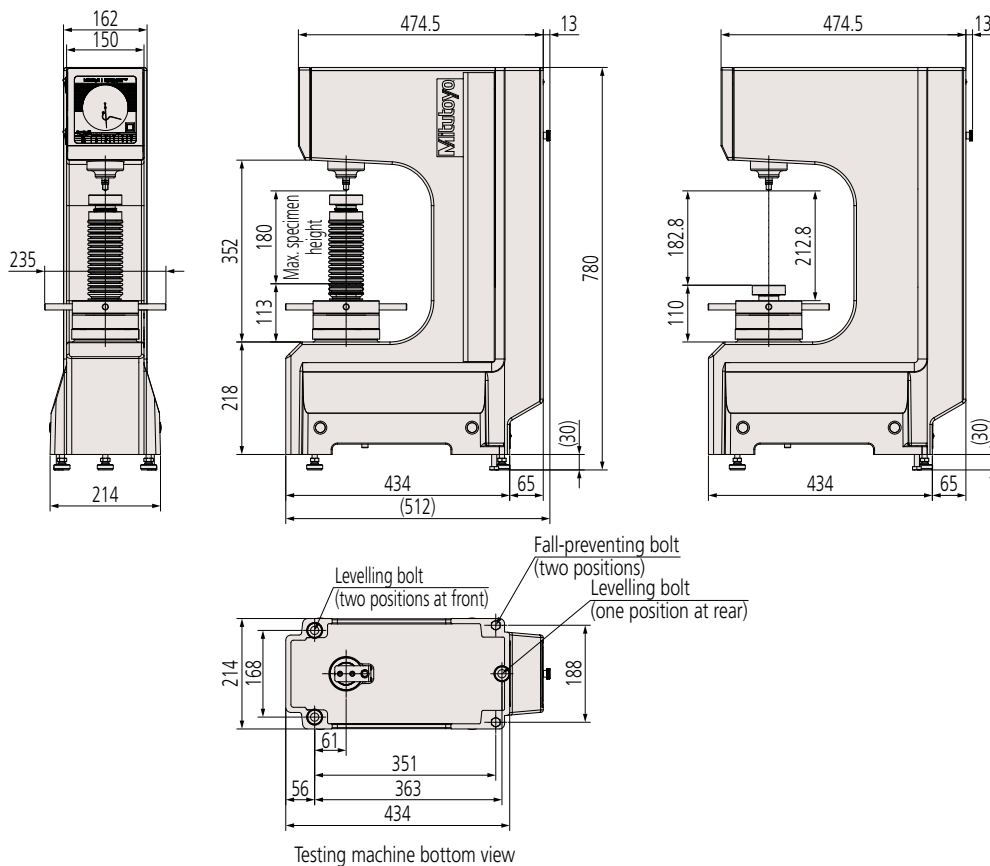

HR-320MS

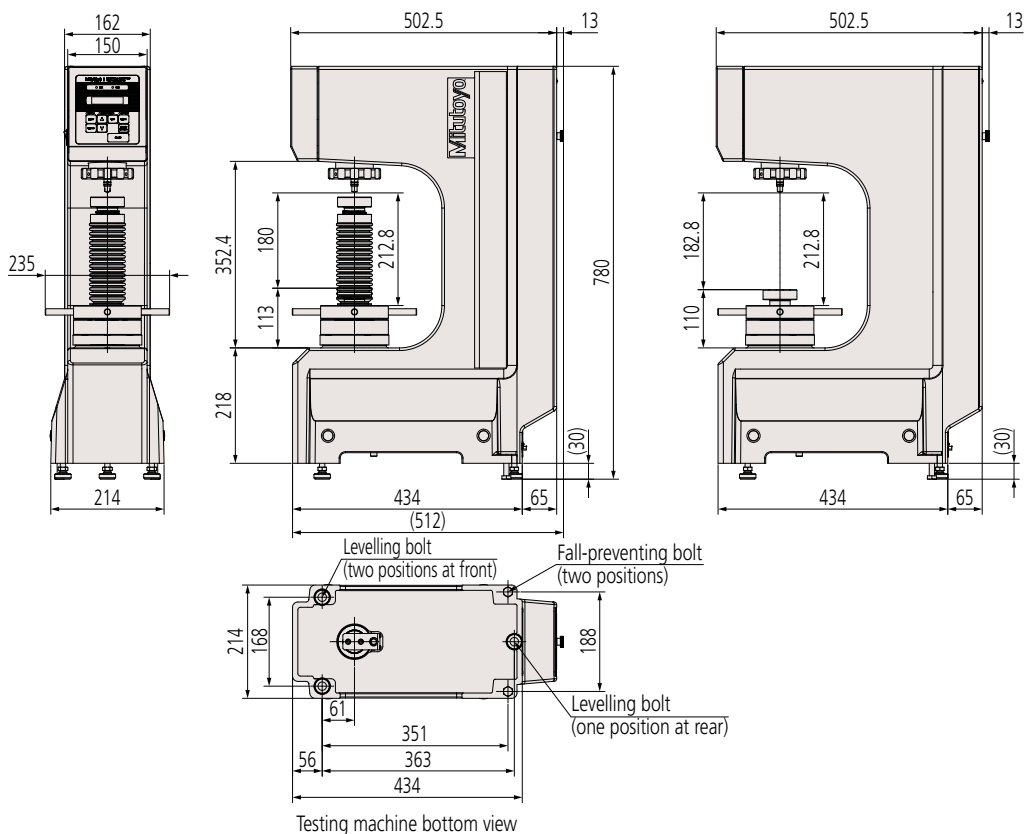

Dimensions

Rockwell Hardness Testing Machines HR-200/300/400 Series

HR-430MR

Unit: mm

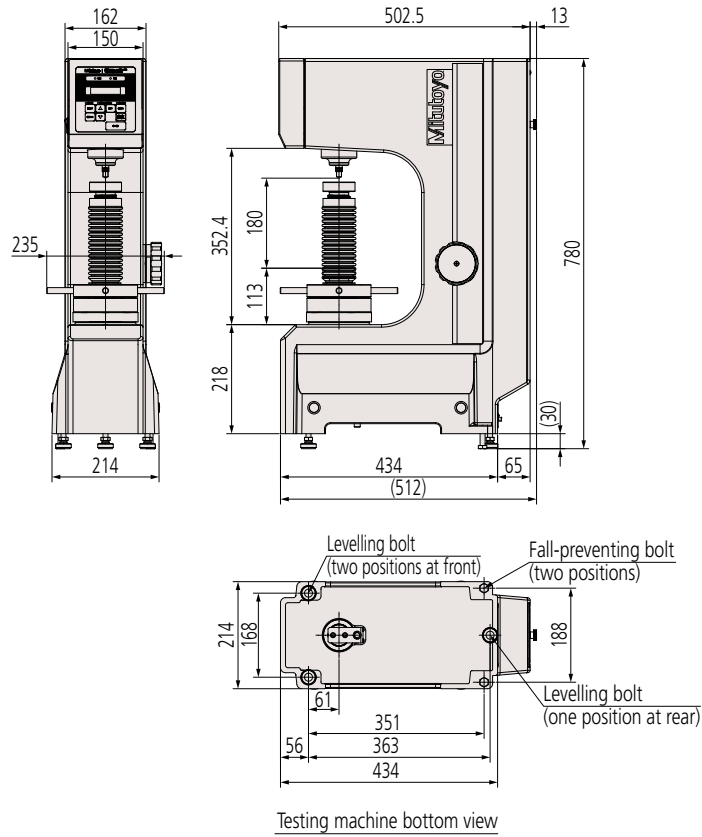

HR-430MS

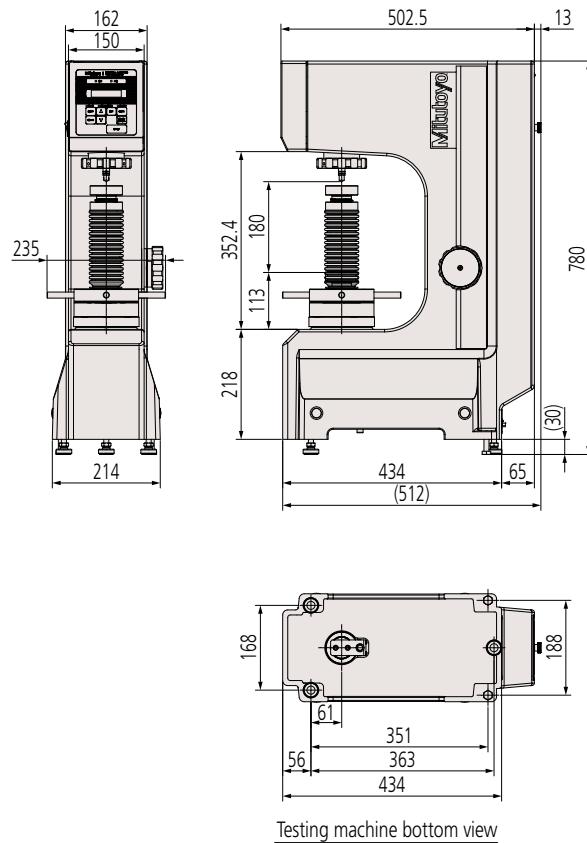

Rockwell Hardness Testing Machines HR-530 Series

HR-530

Unit: mm

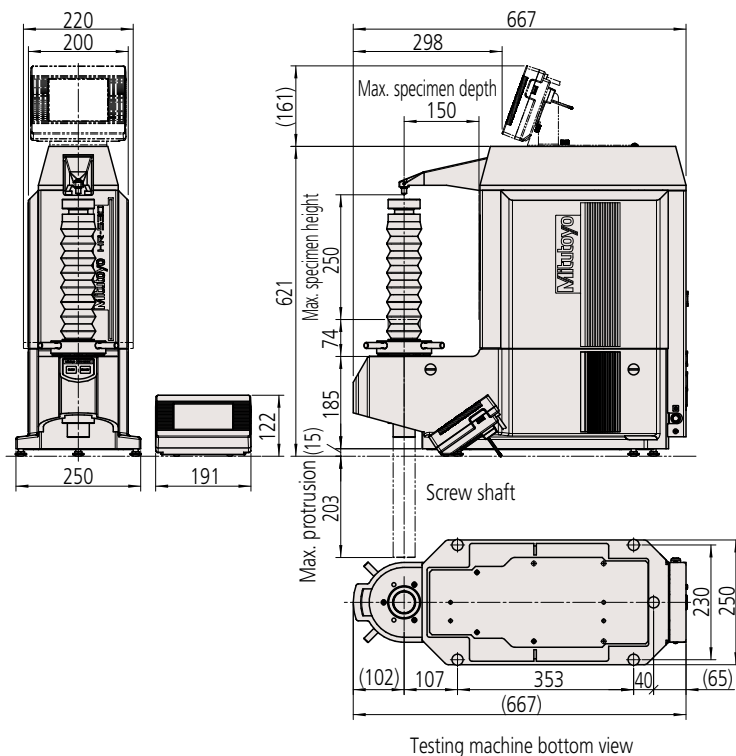

HR-530L

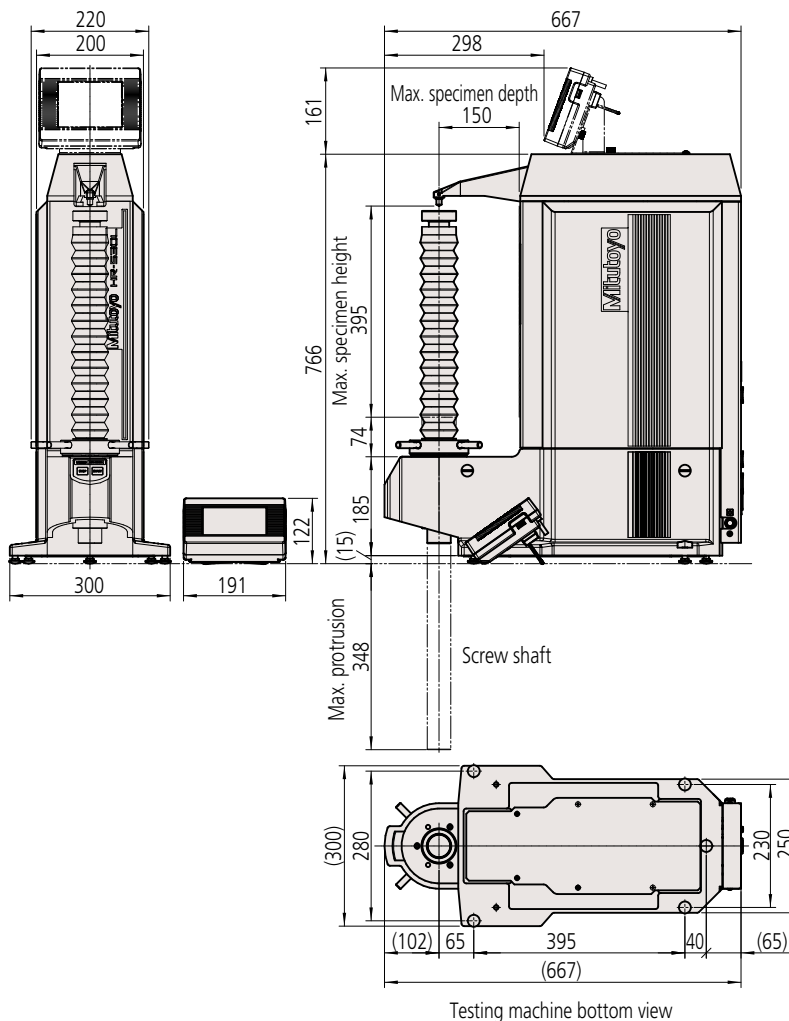

Dimensions

Rockwell Hardness Testing Machines HR-600 Series

HR-610A/620A

Unit: mm

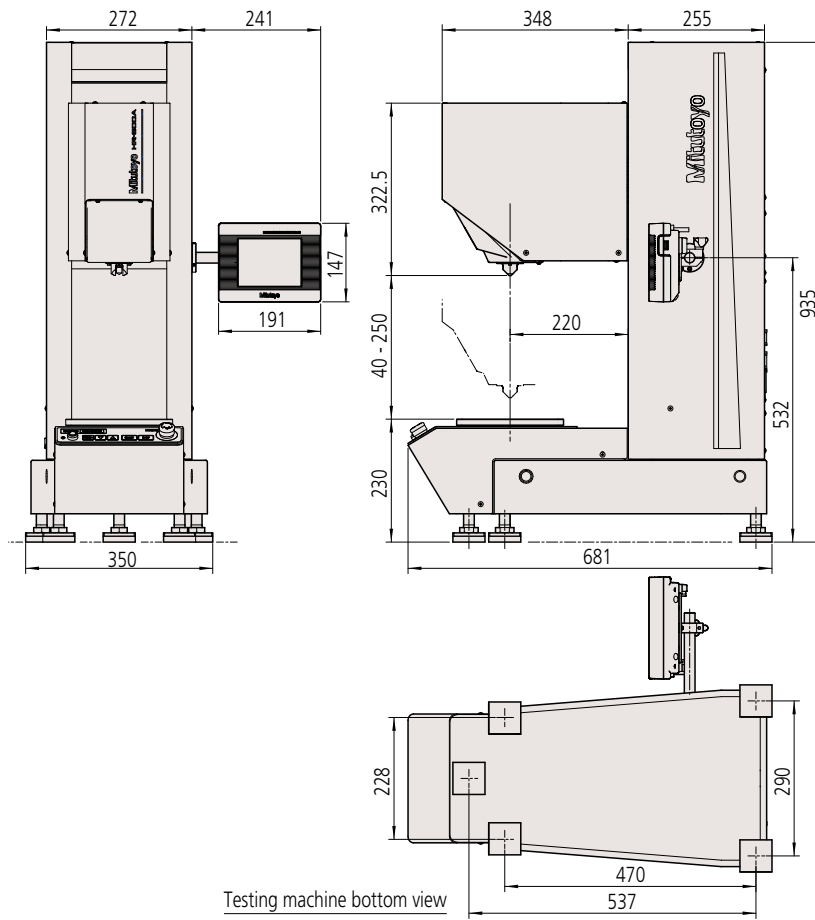

HR-620B

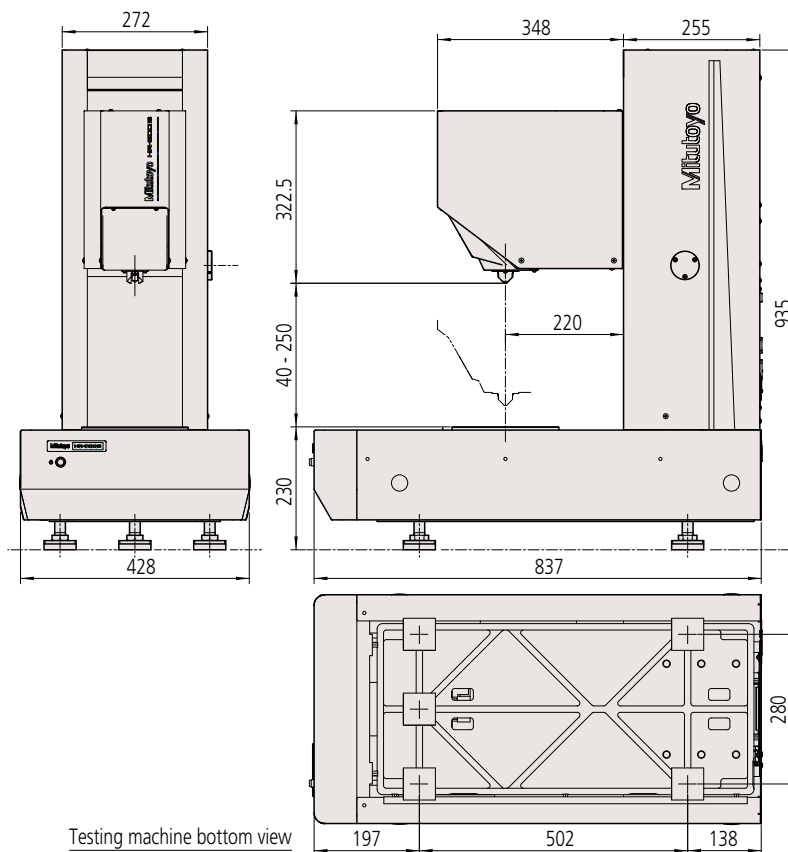

Rebound Type Portable Hardness Tester Hardmatic HH-411

UD-411

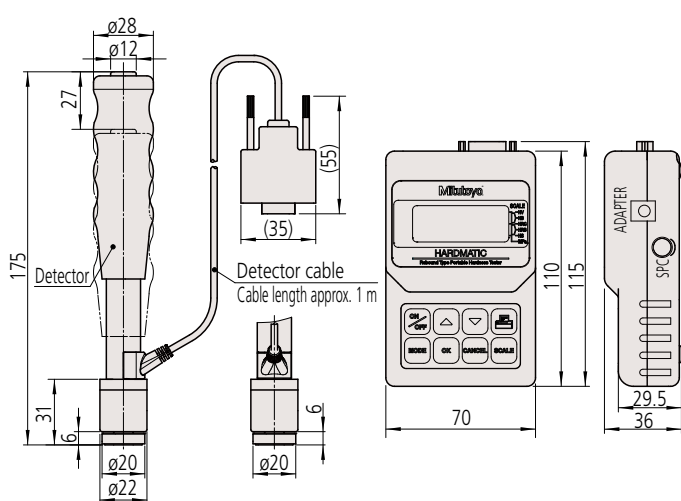

UD-412

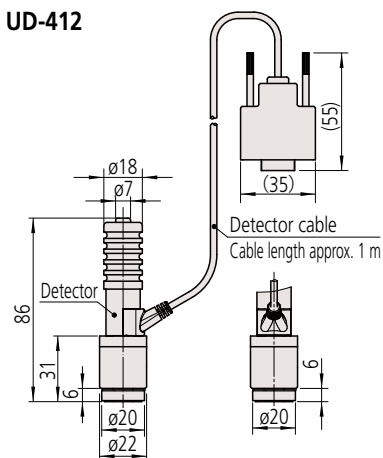

Unit: mm

UD-413

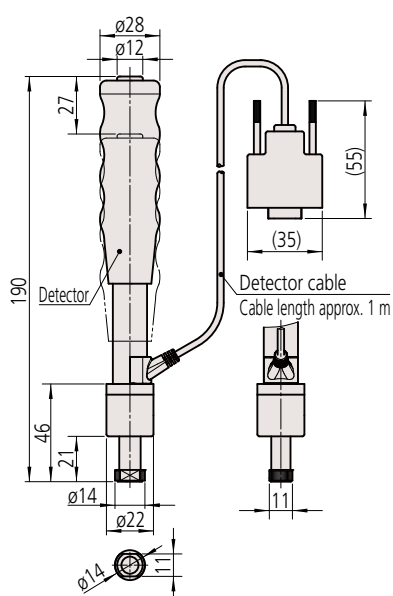

UD-414

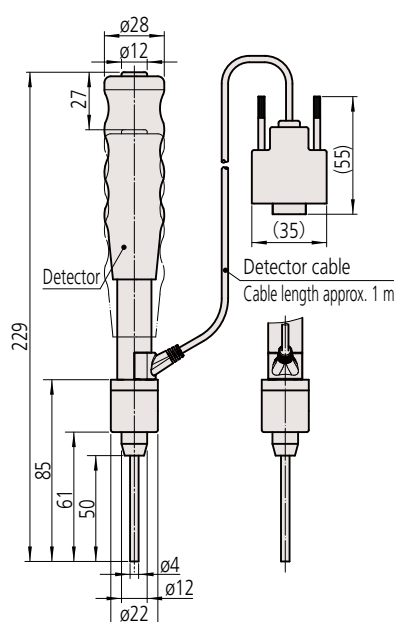

Durometers for Sponge, Rubber, and Plastics Hardmatic HH-300 Series

HH-335

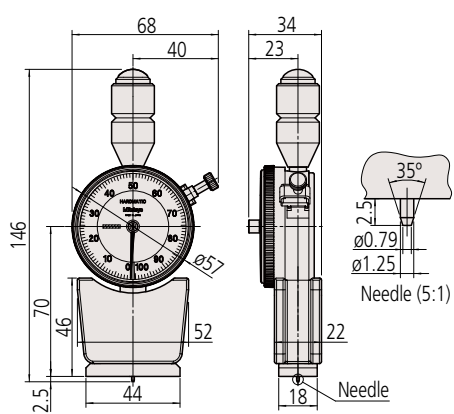

HH-332

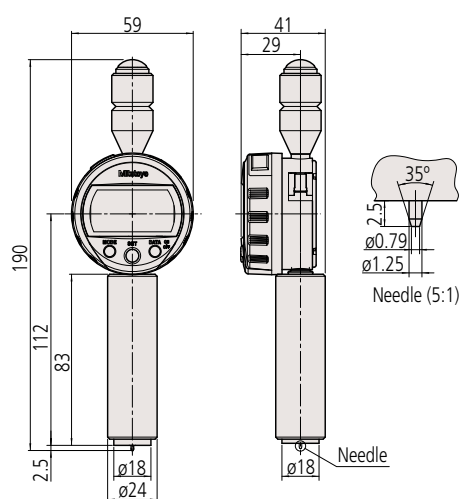

Unit: mm



Whatever your challenges are, Mitutoyo supports you from start to finish.

Mitutoyo is not only a manufacturer of top quality measuring products but one that also offers qualified support for the lifetime of the equipment, backed up by comprehensive services that ensure your staff can make the very best use of the investment.

Apart from the basics of calibration and repair, Mitutoyo offers product and metrology training, as well as IT support for the sophisticated software used in modern measuring technology. We can also design, build, test and deliver measuring solutions and even, if deemed cost-effective, take your critical measurement challenges in-house on a sub-contract basis.



Find additional product literature and our product catalogue

<https://www.mitutoyo.co.jp/global.html>

Our products are classified as regulated items under Japanese Foreign Exchange and Foreign Trade Law. Please consult us in advance if you wish to export our products to any other country. If the purchased product is exported, even though it is not a regulated item (Catch-All controls item), the customer service available for that product may be affected. If you have any questions, please consult your local Mitutoyo sales office.

Note: Product illustrations are without obligation. Product descriptions, in particular any and all technical specifications, are only binding when explicitly agreed upon. MITUTOYO and MICAT are either registered trademarks or trademarks of Mitutoyo Corp. in Japan and/or other countries/regions. Other product, company and brand names mentioned herein are for identification purposes only and may be the trademarks of their respective holders.

Mitutoyo

Mitutoyo Corporation

20-1, Sakado 1-Chome,
Takatsu-ku, Kawasaki-shi,
Kanagawa 213-8533, Japan
T +81 (0) 44 813-8230
F +81 (0) 44 813-8231
<https://www.mitutoyo.co.jp>