

Contour and Surface Roughness Measuring Systems FORMTRACER Avant Series

Form Measurement



Go above and beyond.

FORMTRACER Avant SERIES

Contour and Surface Roughness Measuring Systems

Speed and operability like never before

A revolutionary measuring system that defies conventional thinking.

The hybrid measuring system "FORMTRACER Avant Series" allows measurements both of contour and surface roughness. Endowed with "speed" enabling higher measurement efficiency, "operability" with automation and a wide variety of features, and "expandability" allowing upgrade to a complex system by integrating a detector, this revolutionary measuring system defies conventional thinking.

This is the
Real One.





Mitutoyo

FORMTRACER Avant

0 1 2 3 4
0 10 20 30 40 50 60 70 80 90 100

+OH
0
-OH

Mitutoyo

S-3000CR





CONTRACER



Contour

Continuous upper/lower surface measurement, combined with a measurement adjustable feature*, enables the continuous measurement of upper and lower surface contour, including the effective diameter of screw-threads.

The variable measuring force feature* eliminates the need to adjust the measuring force by switching weights or adjusting orientation. Mounting a contour detector also reduces workpiece handling and expands the Z1-axis (detector stroke) measurement range to greatly improve the efficiency of contour measurement.

* Only when mounting the contour detector C-4500

VARIATION

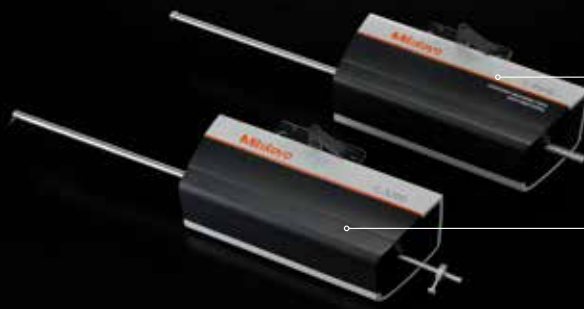

Contour detector
C-4500 (High accuracy)

Contour detector
C-3200 (General-purpose)



SURFTTEST

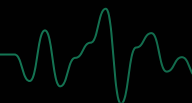

Surface roughness

Compliant with JIS, ISO, ANSI, VDA, and other industrial surface roughness standards.

Rapid movement of the measuring unit, combined with optional accessories to automate leveling of the measuring surface during setup prior to measurement, shortens measurement time and reduces the burden placed on the operator.

VARIATION

OPTION

Roughness detector holder
S-3000CR
(Upward and downward + Crank)

Roughness detector holder
S-3000

OPTION

Roughness detector holder
S-3000MR
(Upward and downward)

OPTION

Roughness detector holder
S-3000C (Crank)



A feature-rich lineup covers every purpose.

This single machine can measure contours and surface roughness.

Just by integrating a detector with a base system comprising FTA-S4C3000/4000 (contour instrument) and FTA-S4S3000 (surface roughness tester), it is possible to upgrade a contour instrument or surface roughness tester to a complex system,

from a general-purpose contour instrument to a high-precision contour instrument.

Three types of surface roughness detector holder can be added for a wider range of surface roughness measurements.

Other than the addition of detectors, Mitutoyo provides a choice of 100/200 mm-type drive units, high-column instruments, and large-sized base instruments, as standard.



Contour Instruments
FTA-S4C3000/4000

Surface Roughness Tester
FTA-S4S3000

Standard model

This is the standard model that constitutes the base for the surface roughness tester and contour instrument. As detectors for roughness and contour can be added to each instrument, a single machine can be used to perform various measurements for which multiple instruments used to be required.



200 mm drive unit, high-column model
Surface Roughness Tester
FTA-H8S3000

200 mm drive unit, large-sized base
instrument with long column model
Surface Roughness Tester
FTA-L8S3000

High-column model

The base instrument is the same size as the standard model, except the column is higher. The extra depth allows a wider range of measurements in the vertical direction.

Large-sized model

This is the large-sized model with the maximum-size base and column. It can efficiently measure heavy and/or long workpieces.

HIGH-SPEED

“Speed-up” greatly reduces measurement time

FORMTRACER Avant Series boast best-in-class drive speed, such as fast movement of drive unit and column, stroke (retraction) speed-up, etc. To meet the needs of “Speed-up,” on surface roughness measurement, the positioning distance from the start of measurement to the start of data acquisition is reduced to the limit, while on contour measurement, the time from touch-down on a workpiece to the start of measurement is shortened. The total measurement time is drastically reduced to improve measurement efficiency.

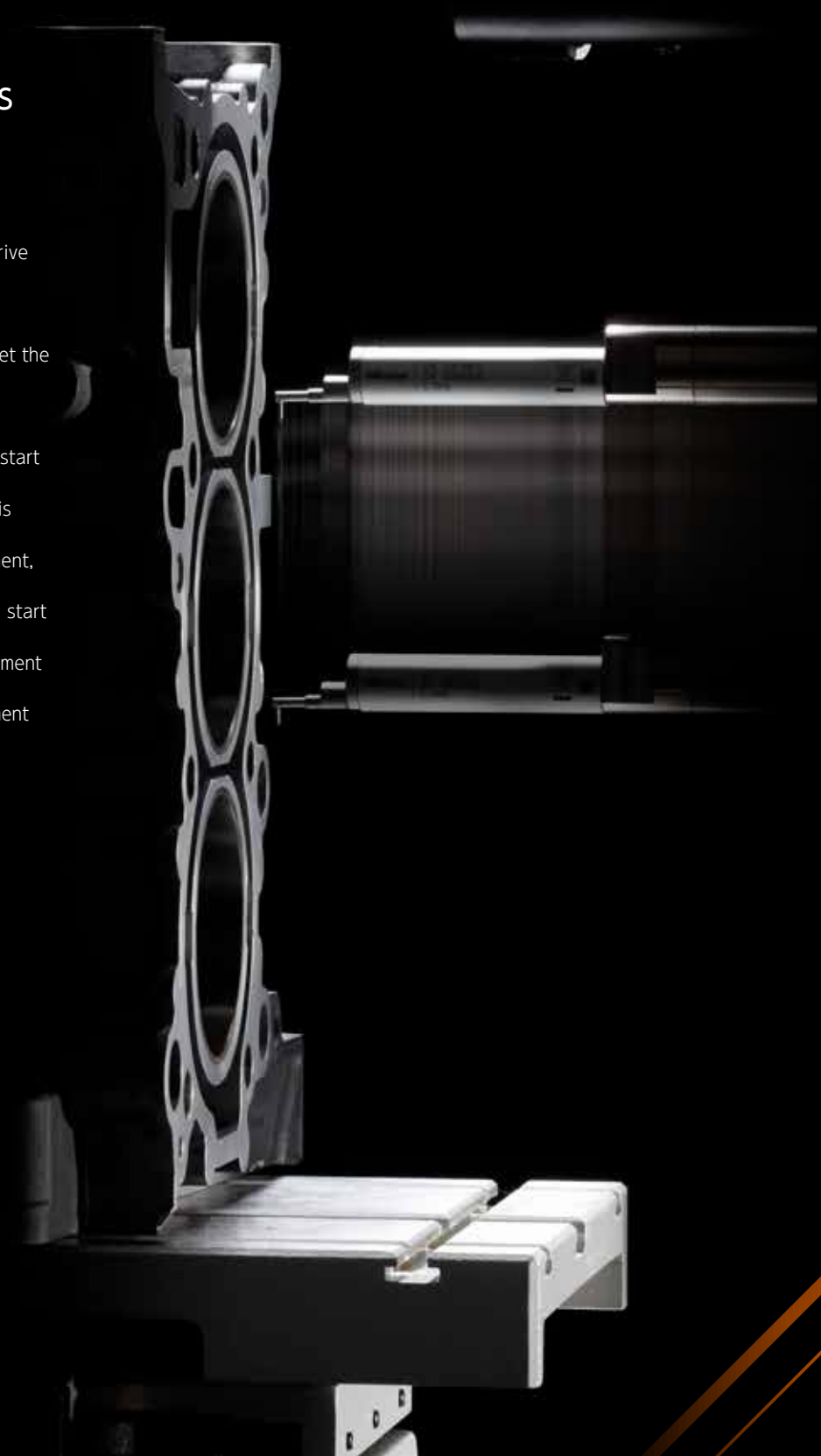

Best-in-class high-speed driving

High-speed driving drastically reduces the measurement time 

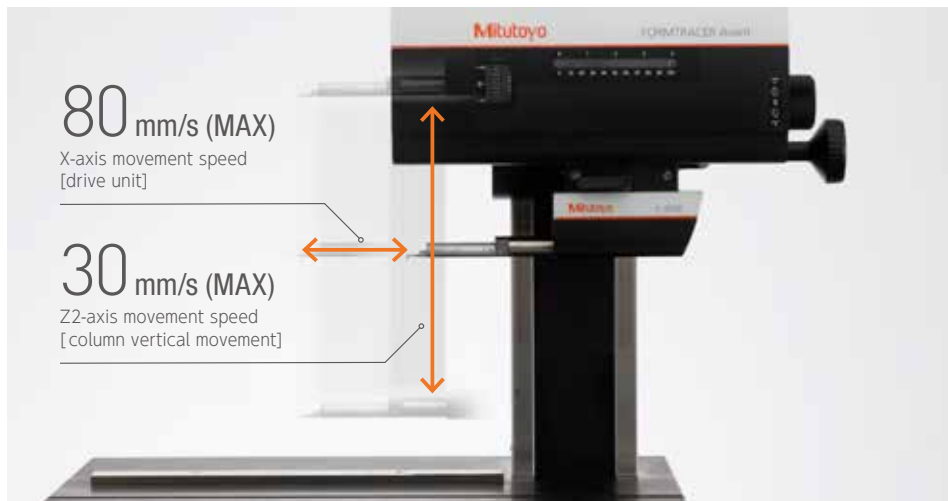

X-axis (drive unit): 80 mm/s (MAX) Z2-axis (column vertical movement): 30 mm/s (MAX)
Speed-up of the movement enables reduction of the total measurement time.

Reduction of the total measurement time

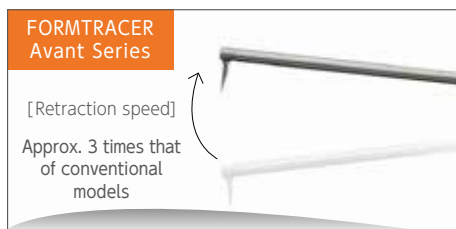

The stroke (retraction) speed is improved by approx. three times compared to conventional models; meanwhile, the speed when the stylus goes down to touch a workpiece becomes slower in consideration of safety. The measuring system automatically detects the workpiece contact, then immediately moves into standby mode for the start of measurement approximately three times faster than a conventional model, for a drastic improvement in measuring efficiency.

Real One
POINT

Cutting down the positioning distance **to its limit**

Industry's
No.1



The positioning distance from the start of measurement to the start of measurement data acquisition is reduced to the absolute minimum of 0.05 mm. The system vigorously supports the measurement of edges and narrow parts where it is difficult to secure sufficient measurement distance.

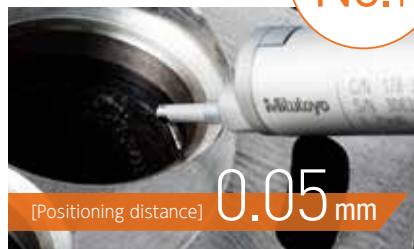

WORKABILITY



Remarkably improved workability with outstanding features

This system uses a cable-less design allowing measurements without having to worry about snagging unprotected detector cables, while the drive section is an X-axis inclinable drive unit. The inclination range is a wide $\pm 45^\circ$, allowing inclined surfaces on of workpieces to be simply measured without using an inclination jig. In addition, the detector can be replaced without turning power off, the guide pin reproduces positioning with high accuracy, and the software supporting the mounted detector starts up automatically. Such outstanding features drastically improve work efficiency.

X-axis inclinable drive unit



To measure inclined surfaces efficiently, an X-axis inclinable drive unit which can measure surfaces within a range of $\pm 45^\circ$ is mounted. When mounting the contour detector C-4500, the measuring force can be varied in 5 steps by using the software provided (FORMTRACEPAK), eliminating the need to adjust the measuring force by switching weights or through positional adjustment. This system can also maintain the specified measuring force even when inclined.

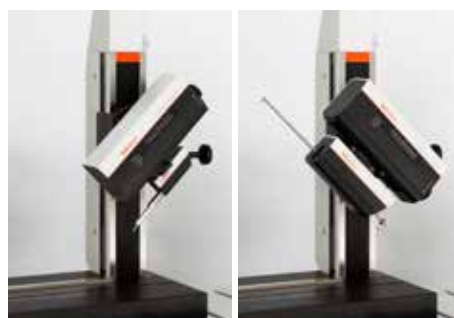

[X-axis drive unit inclination range]

$\pm 45^\circ$

Arc scale



The system features a built-in precision arc scale that allows the circular trajectory of the stylus tip to be read directly, eliminating the need for an arc direct conversion mechanism, which often causes measurement error on the detector. It allows precision measurement over a wide range even if the arm is not in the horizontal attitude. You can perform precision measurement without worrying about the measurement range.



Cable-less

All detector and drive unit cables are housed inside the main unit to eliminate any risk of abrasion or snagging and guarantee precision measurement and rapid movement.



Hot swapping



No need to turn the controller power off when replacing the contour detector or roughness detector; moreover, the tool-less replacement mechanism (thumb-turn clamber) greatly helps to reduce the replacement time by approx. 1/4 (approx. 30 seconds) compared to a conventional model. Further, positioning using the guide pin improves reproducibility when replacing detectors and allows efficient operation of the automatic measuring program.



WORKABILITY

Optimized measurement features depending on characteristics of workpieces

The upper/lower surface continuous measurement feature, performing control of measurement direction and measuring force by double-sided stylus and software, remarkably improves the measurement range. The stylus-drop detection feature immediately stops operation if the stylus suddenly drops, thus preventing damage to the stylus during continuous cut-out measurement without having to rely on a conventional mechanical stop. Other features enable accurate and safe measurements in accordance with the characteristics of a workpiece.



Upper/lower surface continuous measurement

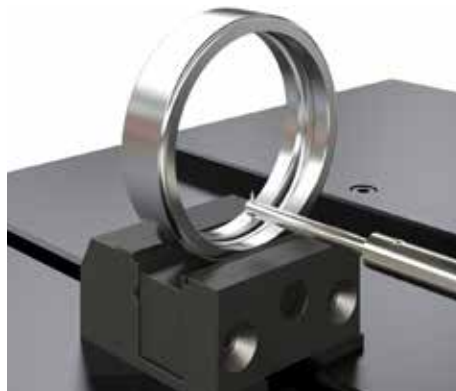

Upper/lower surfaces can be measured continuously by using Mitutoyo's double-sided conical stylus. This continuous measurement data can be used to facilitate analysis of features that were difficult to measure before, such as the effective diameter of an internal screw-thread. The collision monitoring feature for the magnet arm and the detector cover ensures safe measurement even during high-speed movement, in addition, optional accessories for automatic measurement automate processes from the setup to the measurement.

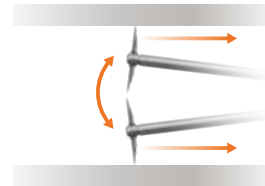

Stylus drop detection feature



Detects sudden drop of the stylus from a measurement surface and stops the measurement operation; also, it controls the dropping rate to avoid breakage of stylus.

Note: When mounting contour detector C-4500

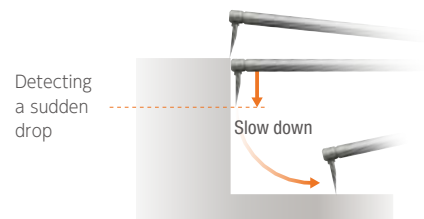

Continuous cut-out measurement feature



The detector hold position can be registered, allowing measurement to be performed without dropping below the preset position. This feature allows continuous measurement of interrupted surface features on workpieces without needing to use mechanical stoppers.

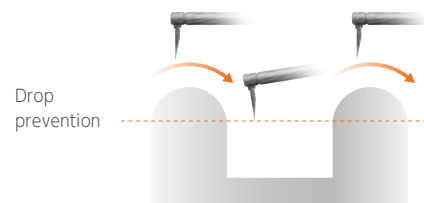

SOFTWARE

Backup for the unified management and sharing of measurement data, and visualization of quality

FORMTRACEPAK is equipped with a wide variety of features, such as control of the contour and surface roughness measuring systems, data analysis and comparison, and report creation. etc. MCubeMap visualizes the analysis data in detail by using various graphical technologies.

MeasurLink integrates measured data to a server via a networking system. Mitutoyo supports the realization of quality improvement by preventing defective products being produced, utilizing unified management and sharing of information.

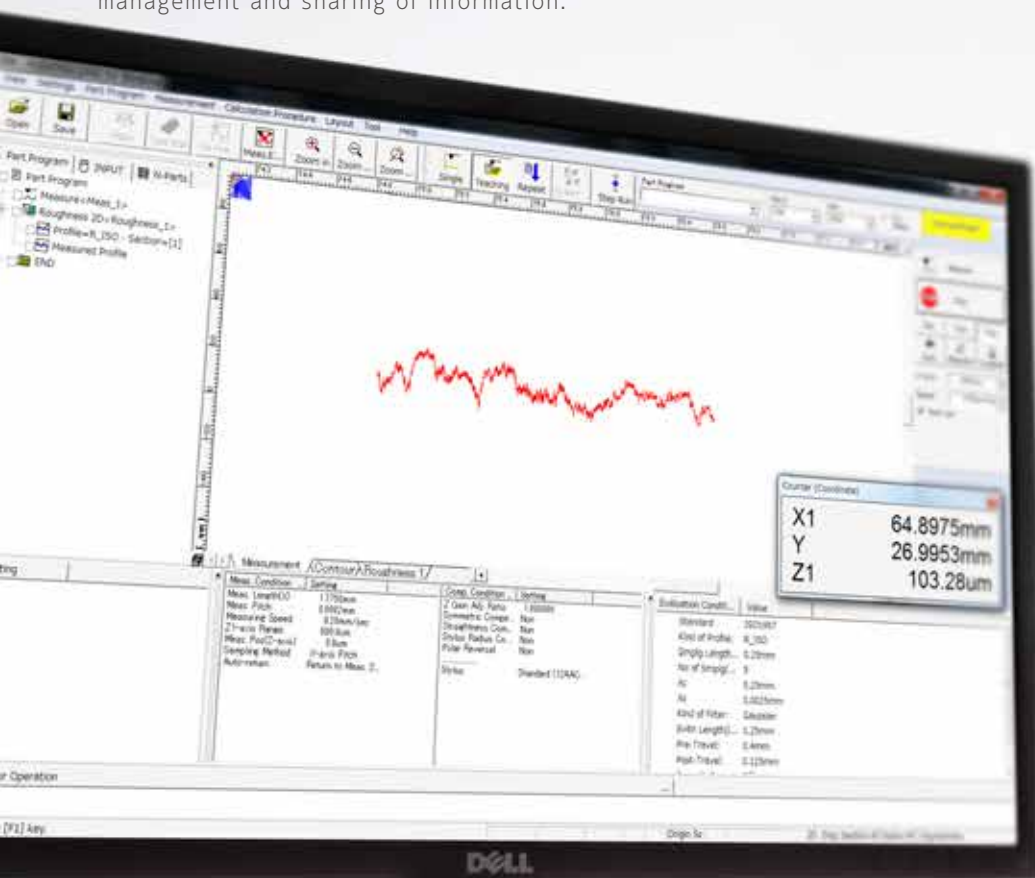

FORMTRACEPAK

<Surface property analysis program>

FORMTRACEPAK features offer total support for controlling the measuring system, surface roughness analysis, contour analysis, contour tolerancing, and inspection report creation.

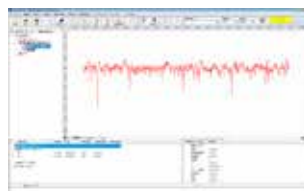

Surface roughness analysis

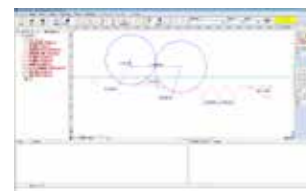

Contour analysis

MCubeMap

<3D surface property analyzing software>

Parameter analysis is available for not only the vertical directions of Sa and Sq, but also spaces, compounds, and features. A wide variety of graphical technologies help visualize the analyzed data in detail.

Note: The Y-axis table for 3D measurement is required separately.

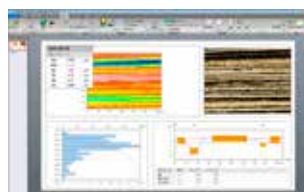

An example of 3D analysis

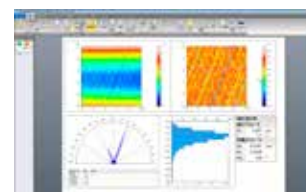

MeasurLink

<Measurement Data Network System>

MeasurLink networks each measuring system and aggregates the measurement data in a server. The real-time aggregation enables "Visible quality" meaning the unified management and sharing of information relevant to quality.

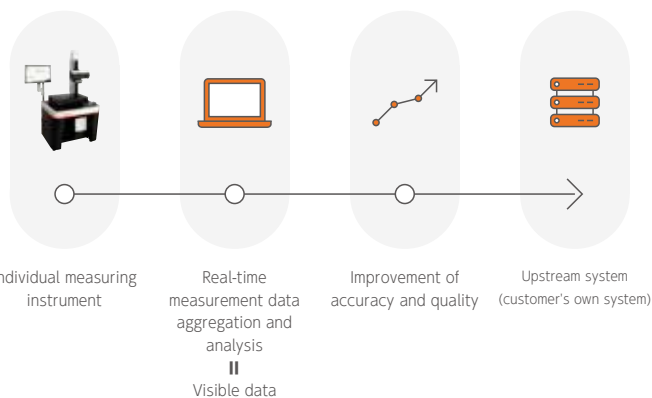

DESIGN

Coexistence of form and functional beauty with no compromise on detail

Visual beauty, functional rationality, and reliable measurement accuracy. We seek product design endowed with all of these. Coexistence of beauty of form in pursuit of design with no compromise on detail, and functional beauty providing both operability and innovation.

In addition to coloring, the new design adds improvements and ingenious features that considers the whole product structure and enables ease of use.



- 1 In addition to coloring, the new design considers both usability and innovation. While inheriting the contractor and surfest tradition, one also senses a leading innovative spirit.
- 2 Applying an angle to the front surface of the vibration isolator and side table helps reduce stress on users who work while standing and provides excellent usability.
- 3 Improved operability thanks to added new features, such as the override control for adjusting the driving speed in real-time, and part program key that assists creation of part programs.
- 4 All detector and drive unit cables are housed inside the main unit to eliminate any risk of abrasion and guarantee precision measurement and rapid movement.



3



4



OPTIONS

Optional accessories for automatic measurement

Mitutoyo offers a wide variety of optional accessories supporting the major reduction of total measurement time, from setup and measurement to evaluation, by enabling quicker implementation of operations, such as measurement of multiple points, alignment of cylindrical workpieces and leveling for surface roughness measurement.



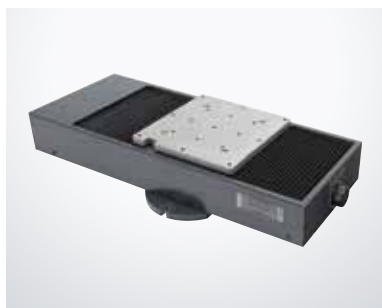

Y-axis table | 178-097

Enables efficient, automatic measurement of multiple aligned workpieces and multiple points on a single surface.



Travel range: 200 mm
Resolution: 0.05 μm
Positioning accuracy: $\pm 3 \mu\text{m}$
Drive speed: Max 80 mm/s
Maximum load: 50 kg
Mass: 28 kg

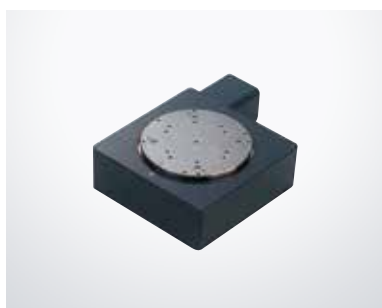

Rotary table | $\theta 1$ -axis table | 12AAD975

For efficient measurement in the axial/transverse directions. When measuring a cylindrical workpiece, automatic alignment can be performed in combination with the Y-axis table.
 (* $\theta 1$ -axis mounting plate <Option: 12AAE630> is required when directly installing on the base of the FORMTRACER Avant.)

Displacement: 360°
Resolution: 0.004°
Maximum load: 12 kg
Rotational speed:
 Max 10°/s
Mass: 7 kg

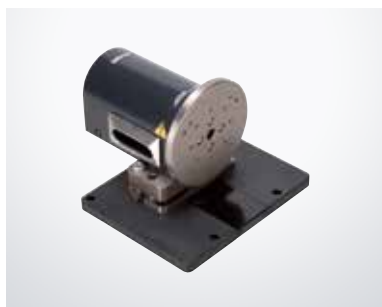

Rotary table | $\theta 2$ -axis unit | 178-078

You can measure multiple points on a cylindrical workpiece and automate front/rear-side measurement.
 (* $\theta 2$ -axis mounting plate <Option: 12AAE718> is required when directly installing on the base of the FORMTRACER Avant.)

Displacement: 360°
Resolution: 0.0072°
Maximum load (loading moment):
 4 kg (moment 343 N-cm or less)
Rotational speed:
 Max 18°/s
Mass: 5 kg



Auto leveling table | 178-087

This table performs fully automatic leveling adjustment roughness measurement surfaces at the start of measurement. Full automation ensures rapid measurement regardless of the skill level of the operator.

Inclination adjustment angle: $\pm 2^\circ$
Maximum load: 7 kg
Table dimensions: 130×100 mm
Mass: 3.5 kg



Drive unit DAT unit | 178-050

This optional unit supports leveling of measurement surfaces by inclining the drive unit. This makes leveling easy when working with large workpieces that are hard to place on the auto leveling table.

Inclination range: $\pm 1.5^\circ$
Mass: 6.7 kg



3-axis adjustment table | 178-047



This table helps make the adjustments required when measuring cylindrical surfaces. The corrections for the pitch angle and the swivel angle are determined from a preliminary measurement and the Digimatic micrometers are adjusted accordingly. A flat-surfaced workpiece can also be leveled with this table. By using Mitutoyo's 3-axis adjustment table, the workpiece can be aligned and leveled easily, simply by following the FORMTRACEPAK guidance. No experience or special expertise is required.

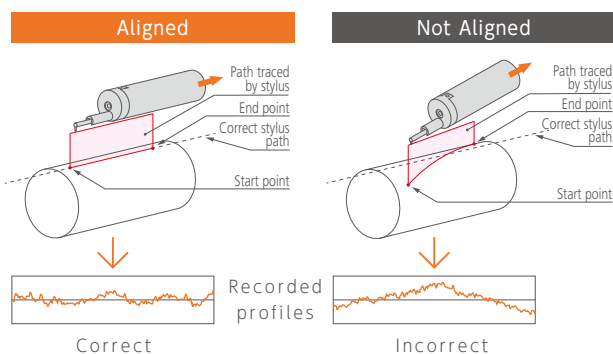

Centering chuck (ring operated) | 211-032



This chuck is useful when measuring small workpieces. You can easily clamp them with its knurled ring.

Holding range:
 Inner jaws OD: $\phi 1 - \phi 36$ mm
 Inner jaws ID: $\phi 16 - \phi 69$ mm
 Outer jaws OD: $\phi 25 - \phi 79$ mm
Dimensions (D×H):
 $\phi 118 \times 41$ mm
Mass: 1.2 kg

Micro-chuck | 211-031



This chuck is suitable for clamping extra-small diameter workpieces ($\phi 1$ mm or less), which cannot be retained with the centering chuck.

Holding range:
 OD: $\phi 0.2 - \phi 1.5$ mm
Dimensions (D×H):
 $\phi 107 \times 48.5$ mm
Mass: 0.6 kg



Table and fixture systems

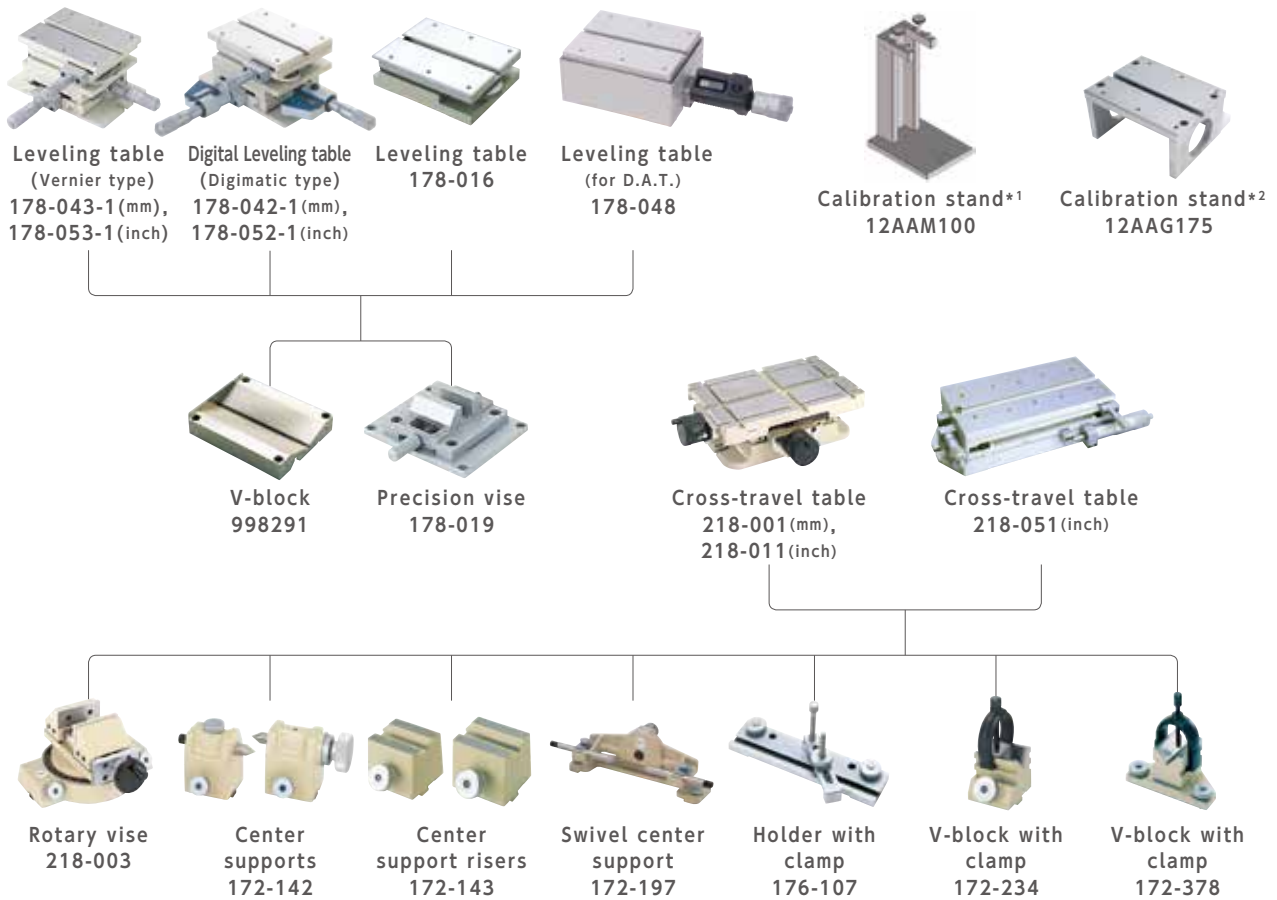

Desktop type vibration isolators

Manually charged pneumatic type*3
178-023



Automatically charged pneumatic type*3
178-025



Automatically charged pneumatic type*4
178-115



Stand for desktop type

● Stand for Desktop type for 178-023 and 178-025.

External size (W×D×H): 640×470×660 mm
Mass: 25 kg
178-024

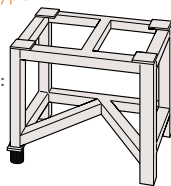

Measurement workbench

(for standard base)
12AAQ587
External size (W×D×H): 900×750×740 mm
Maximum loading: 300 kg

Measurement workbench

(for wide base)
12AAQ583
● Stand for Desktop type for 178-115.
External size (W×D×H): 1500×900×740 mm
Maximum loading: 800 kg

Desk type vibration isolators

Desk type*3
(Stand integrated type, air system)
178-188

Side table*5
178-181



Example combination: with side table but no monitor arm (tester and PC not included)

Desk type*4
(Stand integrated type, air system)
178-189

Monitor arm*5
12AAK120



Example combination: with monitor arm but no side table*6 (tester and PC not included)

*1 Required for calibrating upward measurement of FTA-**C3000/**D3000 series. (Contour measurement)

*2 Required for calibrating in bulk by mounting straight arm / small-hole stylus arm without using cross-travel table and Y-axis table. (Contour measurement)

*3 For models with a product code that ends in S4, S8, H4, or H8.

*4 For models with a product code that ends in W4, W8, L4 or L8 (wide base models).

*5 Used together with desk types (178-188 or 178-189).

*6 User to provide a printer rack.



unit: mm

Stylus name	Stylus No.	Order No.	Application arm No.	H (mm)
Double-sided conical stylus*1	SPHW-56	12AAM095*2	AB-31, AB-37	20
	SPHW-66	12AAM096	AB-31, AB-37	32
	SPHW-76	12AAM097	AB-31, AB-37	48
One-sided cut stylus	SPH-51	354882	AB-31, AB-37	6
	SPH-61	354883	AB-31, AB-37	12
	SPH-71	354884*2 *3	AB-31, AB-37	20
	SPH-81	354885	AB-31, AB-37	30
	SPH-91	354886	AB-31, AB-37	42
	Intersecting cut stylus	SPH-52	354887	AB-31, AB-37
SPH-62		354888	AB-31, AB-37	12
SPH-72		354889	AB-31, AB-37	20
SPH-82		354890	AB-31, AB-37	30
SPH-92		354891	AB-31, AB-37	42
Cone stylus Tip angle 30° Sapphire tipped	SPH-53	354892	AB-31, AB-37	6
	SPH-63	354893	AB-31, AB-37	12
	SPH-73	354894	AB-31, AB-37	20
	SPH-83	354895	AB-31, AB-37	30
	SPH-93	354896	AB-31, AB-37	42
Cone stylus Tip angle 30° Carbide-tipped	SPH-56	12AAA566	AB-31, AB-37	6
	SPH-66	12AAA567	AB-31, AB-37	12
	SPH-76	12AAA568	AB-31, AB-37	20
	SPH-86	12AAA569	AB-31, AB-37	30
	SPH-96	12AAA570	AB-31, AB-37	42
Cone stylus Tip angle 20° Carbide-tipped	SPH-57	12AAE865	AB-31, AB-37	6
	SPH-67	12AAE866	AB-31, AB-37	12
	SPH-77	12AAE867	AB-31, AB-37	20
	SPH-87	12AAE868	AB-31, AB-37	30
	SPH-97	12AAE869	AB-31, AB-37	42
Cone stylus Tip angle 50° Diamond tipped	SPH-79	355129	AB-31, AB-37	20
Knife edge stylus	SPH-54	354897	AB-31, AB-37	6
	SPH-64	354898	AB-31, AB-37	12
	SPH-74	354899	AB-31, AB-37	20
	SPH-84	354900	AB-31, AB-37	30
	SPH-94	354901	AB-31, AB-37	42
Ball stylus	SPH-55	354902	AB-31, AB-37	6
	SPH-65	354903	AB-31, AB-37	12
	SPH-75	354904	AB-31, AB-37	20
	SPH-85	354905	AB-31, AB-37	30
	SPH-95	354906	AB-31, AB-37	42
	Small hole stylus	SPH-41	12AAM104	AB-33
SPH-42		12AAM105	AB-33	4
SPH-43		12AAM106	AB-33	6.5

Double-sided conical stylus

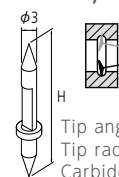

Tip angle: 30°
Tip radius: 25 μm
Carbide-tipped

One-sided cut stylus

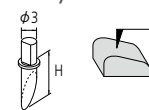

Tip angle: 12°
Tip radius: 25 μm
Carbide-tipped

Intersecting cut stylus

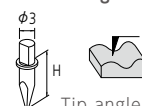

Tip angle: 20°
Tip radius: 25 μm
Carbide-tipped

Cone stylus

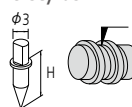

Tip angle: 30°
(SPH-79: 50°)
Tip radius: 25 μm
Sapphire, Carbide-tipped
(SPH-79: Diamond tipped)

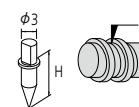

Tip angle: 20°
Tip radius: 25 μm
Carbide-tipped

Knife edge stylus

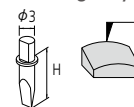

Tip angle: 20°
Edge width: 3 mm
Tip radius: 25 μm
Carbide-tipped

Ball stylus

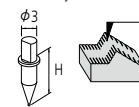

Ball dia: 1 mm
Carbide-tipped

Small hole stylus SPH-41

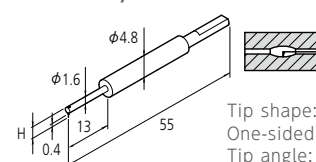

Tip shape:
One-sided cut
Tip angle: 20°
Tip radius: 25 μm
Carbide-tipped

Small hole stylus SPH-42

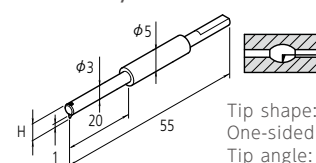

Tip shape:
One-sided cut
Tip angle: 20°
Tip radius: 25 μm
Carbide-tipped

Small hole stylus SPH-43

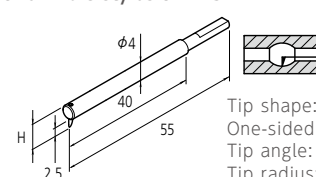

Tip shape:
One-sided cut
Tip angle: 20°
Tip radius: 25 μm
Carbide-tipped

For contour measurement | Arms

Arm name	Arm No.	Parts No.	Applicable stylus No.
Straight arm	AB-31*4	12AAM101	SPH-5*, 6*, 7*, 8*, 9*, SPHW*5 - 56, 66, 76
Eccentric arm	AB-37	12AAQ762	SPH-5*, 6*, 7*, 8*, 9*, SPHW*5 - 56, 66, 76
Small-hole arm	AB-33	12AAM103	SPH-41, 42, 43

unit: mm

| Straight arm AB-31

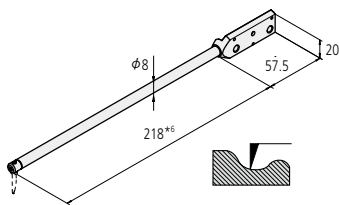

| Eccentric arm AB-37

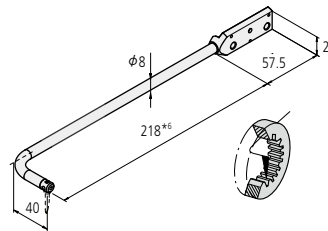

| Small-hole arm AB-33

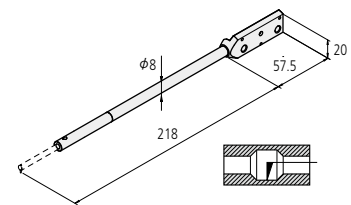

For contour measurement | Arm stylus (comprising an arm and stylus)

Arm stylus name	Stylus No.	Parts No.	H (mm)
Double-sided small hole arm stylus*7	SPHW-21	12AAT469	2.4
	SPHW-22	12AAT470	5
	SPHW-31	12AAM108	2.4
	SPHW-32	12AAM109	5
	SPHW-33	12AAM110	9

unit: mm

| Double-sided small hole arm stylus SPHW-21/31

| Double-sided small hole arm stylus SPHW-22/32

| Double-sided small hole arm stylus SPHW-33

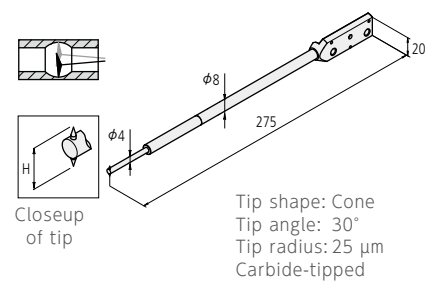
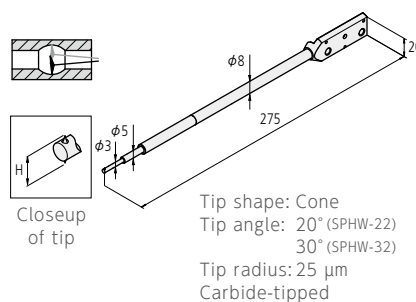
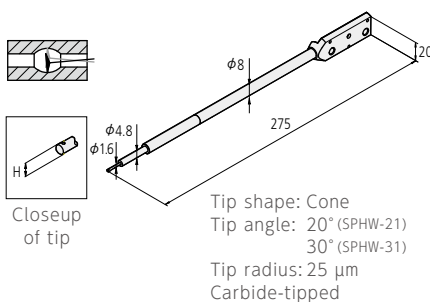

*1 Stylus for contour detector C-4500. *2 Standard accessory of FTA-**C4000/D4000 series. *3 Standard accessory of FTA-**C3000/D3000 series.

*4 Standard accessory of FTA-**C3000/C4000/D3000/D4000 series. *5 Stylus for FTA-**C4000/D4000 series. *6 One-sided cut stylus SPH-71 (standard accessory) mounting.

*7 Arm Stylus for FTA-**C4000/D4000 series.

For Surface Roughness Measuring | Detectors

unit: mm

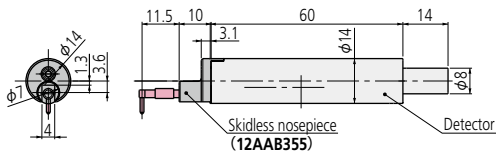

Order No.	Measuring force	
178-396-2	0.75 mN	Detectors that comply with ISO 4278
178-397-2	4 mN	Detectors that comply with previous standards, for general use.

For Surface Roughness Measuring | Extension rods

Extension rod 50 12AAG202 Extension length 50 mm



Extension rod 100 12AAG203 Extension length 100 mm



Note: No more than one extension rod can be connected.

For Surface Roughness Measuring | Styli

unit: mm

Standard stylus

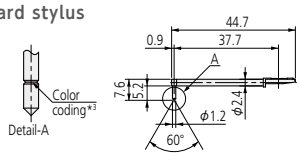

12AAE882 (1 μm)
12AAE924 (1 μm)*1
12AAC731 (2 μm)
12AAB403 (5 μm)*1
12AAB415 (10 μm)*1
12AAE883 (250 μm)*4
(): Tip radius

Double-length for deep hole*2

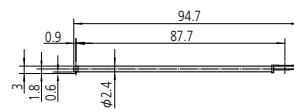

12AAE898 (2 μm)
12AAE914 (5 μm)*1
(): Tip radius

For small hole

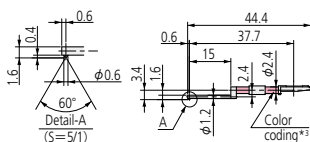

12AAC732 (2 μm)
12AAB404 (5 μm)*1
12AAB416 (10 μm)*1
(): Tip radius

For small hole/Double-length for deep hole*2

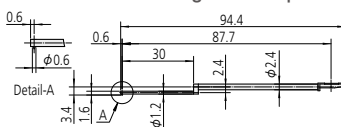

12AAE892 (2 μm)
12AAE908 (5 μm)*1
(): Tip radius

For extra-small hole

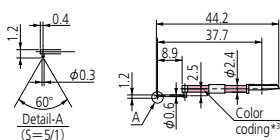

12AAC733 (2 μm)
12AAB405 (5 μm)*1
12AAB417 (10 μm)*1
(): Tip radius

For small hole*2 *4

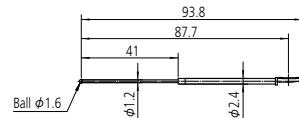

12AAE884 (φ1.6 mm)

For extra-minute hole

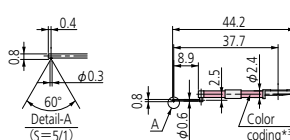

12AAC734 (2 μm)
12AAB406 (5 μm)*1
12AAB418 (10 μm)*1
(): Tip radius

For ultra-small hole*4

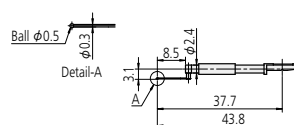

12AAJ662 (φ0.5 mm)

unit: mm

For deep hole (double-length and triple-length)*2

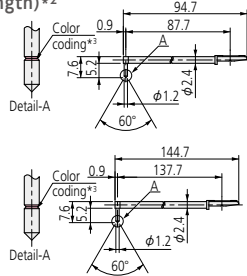

2X stylus
12AAC740 (2 μm)
12AAB413 (5 μm)*1
12AAB425 (10 μm)*1
 (:): Tip radius

3X stylus
12AAC741 (2 μm)
12AAB414 (5 μm)*1
12AAB426 (10 μm)*1
 (:): Tip radius

For small slotted hole*2

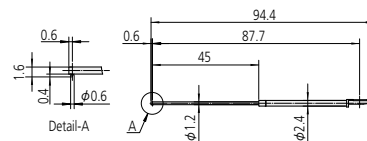

12AAE938 (2 μm)
12AAE940 (5 μm)*1

For deep groove (10 mm)

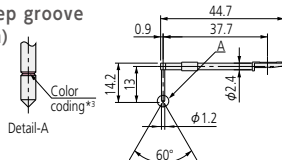

12AAC735 (2 μm)
12AAB409 (5 μm)*1
12AAB421 (10 μm)*1
 (:): Tip radius

For deep groove*2 (20 mm)

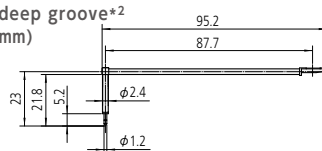

12AAE893 (2 μm)
12AAE909 (5 μm)*1
 (:): Tip radius

For deep groove*2 (20 mm)

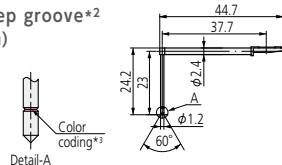

12AAC736 (2 μm)
12AAB408 (5 μm)*1
12AAB420 (10 μm)*1
 (:): Tip radius

For deep groove*2 (40 mm)

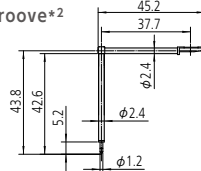

12AAE895 (2 μm)
12AAE911 (5 μm)*1
 (:): Tip radius

For deep groove*2 (30 mm)

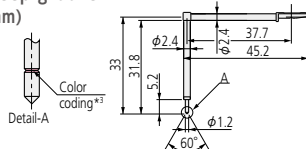

12AAC737 (2 μm)
12AAB407 (5 μm)*1
12AAB419 (10 μm)*1
 (:): Tip radius

For deep groove (30 mm) / Double-length for deep hole*2

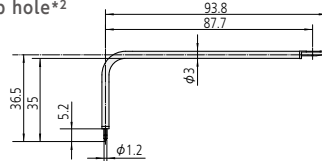

12AAE894 (2 μm)
12AAE910 (5 μm)*1
 (:): Tip radius

For gear tooth

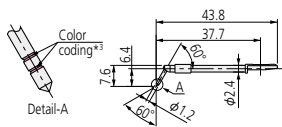

12AAB339 (2 μm)
12AAB410 (5 μm)
12AAB422 (10 μm)
 (:): Tip radius

For gear tooth / Double-length for deep hole*2

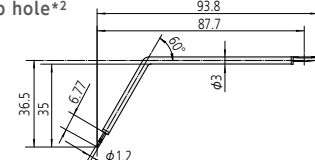

12AAE896 (2 μm)
12AAE912 (5 μm)
 (:): Tip radius

For rolling circle waviness surface*4

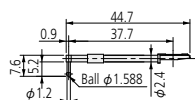

12AAB338 (φ1.588)

For rolling circle waviness / Double-length for deep hole*2 *4

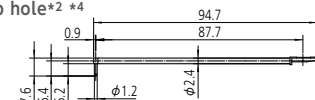

12AAE886 (250 μm)

For knife-edge

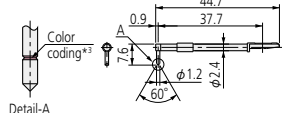

12AAC738 (2 μm)
12AAB411 (5 μm)*1
12AAB423 (10 μm)*1
 (:): Tip radius

For corner hole / Double-length for deep hole*2

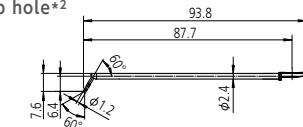

12AAM601 (2 μm)
12AAM603 (5 μm)
 (:): Tip radius

For eccentric arm*2

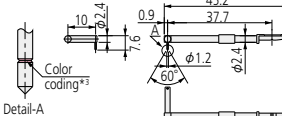

12AAC739 (2 μm)
12AAB412 (5 μm)*1
12AAB424 (10 μm)*1
 (:): Tip radius

For bottom surface

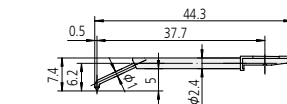

12AAE899 (2 μm)
12AAE915 (5 μm)*1
 (:): Tip radius

*1 Tip angle 90°

*2 For downward-facing measurement only.

*3

Tip radius	1 μm	2 μm	5 μm	10 μm	250 μm
Color coding	White	Black	No color	Yellow	No notch or color

*4 Used for calibration, a standard step gauge (178-611, option) is also required

*Customized special interchangeable styli are available on request. Please contact any Mitutoyo office for more information.

APPLICATION

Efficient precision measurement for practically any workpiece

FORMTRACER Avant Series has applications supporting measurements for a wide variety of workpieces. For example, a part-program (automatic measuring program) creation support key equipped with the remote BOX allows rapid creation of programs, and the contour sensor allows immediate measurement by creating a measurement-ready state once the sensor contacts a workpiece. Further, this series features stylus-up speed three times faster than conventional models, and each axis movement speed is fast, too. By combining these elements into a single system, efficient and accurate measurements are realized.

PET bottle Preform measurement



The thread of a familiar PET bottle requires precision measurement, since leaks will occur if it is too loose, or the cap cannot be tightened if it is too tight. The “sectional form of thread” of such PET bottles can be measured without cutting the product by using a cone stylus. Angle and pitch can be measured efficiently.

Screw gauge Ring measurement



Upper/lower surface continuous measurement and measurement adjustable feature on the C-4500 detector allows simultaneous measurements of the effective diameter of screw or ring gages, together with thread angle and pitch. Since a part-program (automatic measuring program) for measuring and analysis can be created, effective diameter, which requires high accuracy in micrometer threads, can be accurately and efficiently measured.

Golf club face Groove form measurement 



Groove pitches, groove intervals, and edge shapes are strictly determined by golf club standards. By using the part-program (automatic measuring program) as a standard feature and automating analysis, efficient evaluation is possible with precision measurement.

Can Pull-top groove measurement 



If the pull-top groove is too shallow, the pull-top cannot be opened, and if it is too deep, it will be opened easily, resulting in leakage during transportation due to vibration or shock. The groove dimensions of products can be efficiently controlled for measured where high accuracy is required.

Surface roughness test for tooth faces of gears 

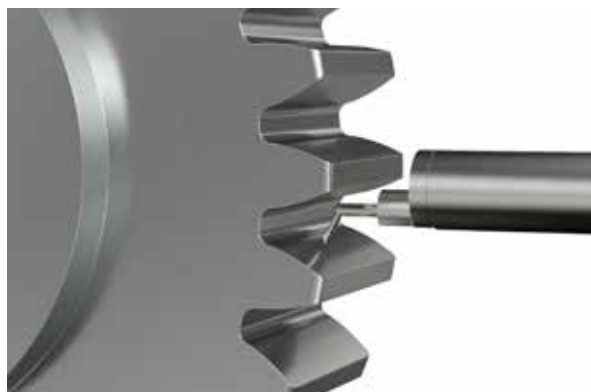

The surface roughness of gear teeth may affect strength and torque transfer efficiency. By using a stylus for gear teeth, it is possible to measure over the full face of a tooth, right down to the root. FORMTRACER Avant Series, which can cut off the positioning distance to its limit (0.05 mm) helps evaluate the surface roughness of gear teeth.

Surface roughness test for tablet molds 



Durability is required for tablet molds to ensure the detachability of pharmaceutical powder and reduction of production cost. FORMTRACER Avant Series, which can cut off the positioning distance to its limit, helps evaluate the surface roughness of molds with accuracy and precision as it can measure products with high accuracy from edge to edge.



Whatever your challenges are, Mitutoyo supports you from start to finish.

Mitutoyo is not only a manufacturer of top quality measuring products but one that also offers qualified support for the lifetime of the equipment, backed up by comprehensive services that ensure your staff can make the very best use of the investment.

Apart from the basics of calibration and repair, Mitutoyo offers product and metrology training, as well as IT support for the sophisticated software used in modern measuring technology. We can also design, build, test and deliver bespoke measuring solutions and even, if deemed cost-effective, take your critical measurement challenges in-house on a sub-contract basis.



Find additional product literature
and our product catalogue

<https://www.mitutoyo.co.jp/global.html>

**Our products are classified as regulated items under Japanese Foreign Exchange and Foreign Trade Law. Please consult us in advance if you wish to export our products to any other country.
If the purchased product is exported, even though it is not a regulated item (Catch-All controls item), the customer service available for that product may be affected. If you have any questions, please consult your local Mitutoyo sales office.**

Note: Product illustrations are without obligation. Product descriptions, in particular any and all technical specifications, are only binding when explicitly agreed upon.
MITUTOYO and MICAT are either registered trademarks or trademarks of Mitutoyo Corp. in Japan and/or other countries/regions.
Other product, company and brand names mentioned herein are for identification purposes only and may be the trademarks of their respective holders.

Mitutoyo

Mitutoyo Corporation

20-1, Sakado 1-Chome,
Takatsu-ku, Kawasaki-shi,
Kanagawa 213-8533, Japan
T +81 (0) 44 813-8230
F +81 (0) 44 813-8231
<https://www.mitutoyo.co.jp>